

# A Dual-Parameter Adaptive Timer Decision Algorithm for Load Balancing and Ping-Pong Handover Control in LTE Networks

Salawu Nathaniel<sup>1\*</sup>, Sharifah Hafizah Syed Ariffin<sup>1</sup> and Ali Farzamnia<sup>2</sup>

<sup>1</sup>UTM-MIMOS CoE in Tele Communication Technology, Faculty of Electrical Engineering, Universiti Teknologi Malaysia, Skudai, Johor - 81310, Malaysia; salawunathaniel@gmail.com, sharifah@fke.utm.my

<sup>2</sup>Faculty of Engineering, Universiti Malaysia Sabah (UMS), Malaysia; alifarzamnia@gmail.com

## Abstract

**Background/Objectives:** In order to increase spectral efficiency and lower handover signaling overhead in long term evolution network, load balancing optimisation and ping-pong handover avoidance is important. **Methods/Statistical Analysis:** Here, an algorithm that uses an adaptive timer was developed to run on the network. The network comprises of seven cells numbered 1, 2, 3, 4, 5, 6 and 7 respectively. Each cell is powered by a centrally placed cell equipped with omni-directional antennas to covers its cell area and neighboring cell-edge users. Receive signal strength and cell load estimates were jointly used to model the handover adaptive timer for decision accuracy. **Findings:** Findings were made the validation of the Key Performance Indicators (KPIs) using computer simulations. The KPIs of attention in this research were load balancing index of the network, number of unsatisfied users, cumulative number of ping-pong handover request, cumulative number of non-ping-pong handover request and average throughput of the cell. The results of our proposal out perform two other references cited in literature. In terms of load distribution index specifically, a 95% level was achieved after only 150 load balancing cycles. **Conclusion/Improvements:** The propose solution proves great for its ability to effectively detect ping-pong handover request and non-ping-pong handover request while load balancing decision process is in progress.

**Keywords:** Adaptive Timer, Load Balancing, Long Term Evolution, Ping-Pong Handover, Self-Organising Network

## 1. Introduction

Long Term Evolution (LTE) network provides the benefit of high system capacity, access cost reduction, higher cell throughput, better Quality of Service (QoS) etc. Others benefits of LTE network is that it is suitable for fast and reliable internet services to areas without high-speed internet access. It is also designed to reduce system's latency and better channel quality for its users<sup>1,2</sup>. The network uses beamforming technique based on Multiple-Input and Multiple-Output (MIMO) technology to maximize the spectral efficiency of the system for higher throughput gain.

LTE network parameters are needed to be tuned automatically by network operators in a most economical manner without human intervention unlike

the traditional methods of tuning the few network parameters in the traditional cellular generations. Recently, 3GPP introduced LTE cellular network that is simple in complexity and high in capacity that is meant for future network. LTE is however less considered for manual tuning to avoid additional capital and operational cost during and after deployment. Based on this, 3GPP introduced Self Organizing Networks (SON) in LTE system to automate most offrequent planning, optimization and operational tasks of the network. SON implementation in the network basically aimed at reducing operator's Operational Expenditure (OPEX) and Capital Expenditure (CAPEX)<sup>3,4</sup>. Automatic tuning functionalities of SON will bring drastic improvements in operator's network management. SON capabilities of a mobile network are grouped into three major aspects.

\* Author for correspondence

These are self-configuration, self-optimization and self-healing. Figure 1 briefly compares a network operation with and without SON functionalities<sup>5</sup>. As seen from the figure, when SON functionalities are in place, a new network element could be deployed easily via Plug and-Play mechanism. Quick parameter optimization of SON is also important aspect that needs attention. These quick parameters optimization are in the areas of traffic or load conditions monitoring, self-healing of faulty network elements, handover optimization etc. The effort of this work however is based using Receive Signal Strength (RSS) and cell load to develop an adaptive timer to manage load distribution and ping-pong handover. Based on the network's performance indicator state, SON helps each cell to automatically re-adjust the handover condition for best performance.

Load balancing and ping-pong handover reduction in LTE network based on RSS and cell load is our major concern in this research. Our aim is to reduce ping-pong handover through a mechanism that considers cell load and RSS value to calculate and adaptive timer value for handover triggering.

Ping-pong handover is a situation of back and forth handover of user's terminal within a short period of time with a high number of handover frequency between the same pair of cells<sup>6,7</sup>. Parameter metrics that can control load balancing and ping-pong handover include cell load, RSS, network coverage information, user location area, user movement, user speed etc. However, we used RSS and cell load for simplicity.

Excessive handovers consume network resources when releasing or reserving users. This translates load

imbalance of the network resulting to the continuous impact on the QoS which is undesired. It is important for network vendors to reduce this unwanted effect and hence the need for this research. The problem of unbalanced load is more severe in mobile cellular network like LTE than the traditional network since they were meant primarily to handle voice services. Users accessing services via LTE spend more session time in active state in general when compared with the lower cellular standards designed for voice. For this reason, unbalance network load could continue for a long time period in LTE network than systems designed typically for voice during voice communication. Another problem of load imbalance is that it could pose the problem of frequent session interruptions in LTE network since LTE was designed to use hard handover for its connection transfers. The process of transferring users between serving and target cells has a short time within which transmission is disconnected. Buffering should be used to avoid data loss in this situation. The problem of connection delay and reduced throughput of users are totally not desired for strict applications like real-time gaming, real-time conversational applications or high-speed data transfer.

In literature, there are many research approaches for load balancing and ping-pong handover control in cellular networks<sup>1,3,4,7-10</sup>. In<sup>1</sup>, a new horizontal handover oscillation control algorithm for LTE self-optimizing networks was proposed. The algorithm uses a pre established policy to automatically adjust the hysteresis and Time-To-Trigger (TTT) parameters for ping-pong handover control. They also consider other parameters such as user equipment, type of traffic and speed. The results obtained a good

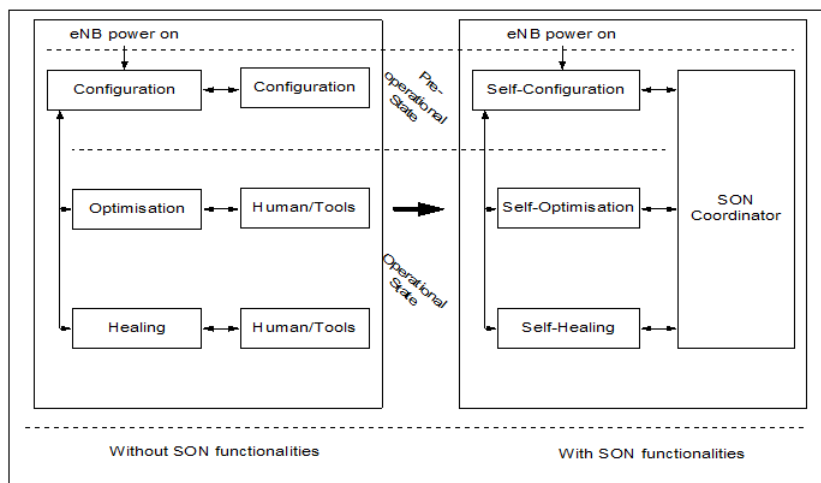


Figure 1. Network operation deployment<sup>5</sup>.

reduction in Handover Performance Indicator (HPI) from 20 to 30% when matched with traditional fixed hysteresis and TTT parameter method. In<sup>3</sup>, analysis of ping pong effect due to load transfer using mobility load balancing in LTE network was done. The research proposed a novel optimizing mechanism of network load balancing based on network manager. It has a centralized-control optimizing mechanism that collects the information of the neighboring cells and their global network information of each enhanced Node B (eNB) to select the appropriate target cell. The simulation results obtained show fast convergence of the network without causing much signaling overhead. They also achieve some improvement in the overall network in terms of throughput. From<sup>4</sup>, a self-optimization load balancing algorithm that is based on automatic adjustment of handover time scheme in an LTE network according to the load status of cells was presented. The proposal is meant to control the load of the serving cell as well as that of the neighboring cell. Whenever there is overload of the serving cell, a handover request is sent to the neighbor cell for handover initiation. Depending on the response of neighbor cellload, the serving cell determines the handover actions based on adaptive timer that will be triggered to balance load. This work however, focuses on load mainly as ping-pong handover issue is not considered along side. The research is however not clear for lack of detail information about the results obtained. In<sup>7</sup>, the impact of ping-pong handover on intere NB handover was investigated. A mechanism for reducing the number of ping-pong handover in the intra Evolved Universal Terrestrial Access (E-UTRA) networks was proposed. The method uses a handover algorithm that delays the handover completion part while keeping the old path between the source eNB and Mobility Management Entity (MME) when ping-pong movement is being executed. Optimal timer value was chosen carefully to determine the best timer value. Their simulation has the best values at 1.5 and 1 sec when user's speed of 25 and 70 km per hour were considered. Their results show that, velocity of the UE can increase the number of dropped calls if the timer value is greater than 1.5 seconds. Consequently, the timer value was made adaptive based on the velocity of the user per time. Also, the research achieved reduction in the rate of ping-pong handover with additional improvement of quality indicator. In<sup>8</sup> presented the analysis of the performance of a self-

optimizing algorithm for handover parameter control that adjusts handover settings depending on the level of oscillations experienced between different cell pairs. They compare the algorithm's performance with two different reference cases based on statistical values obtained over a long period of time. The first one has no protection against oscillations and the second one has strong protection. The proposed algorithm was observed to provide similar protection against oscillations as the second scenario. They achieved in network performance with 20% higher in terms of downlink and uplink throughput. The network however suffers a strong impact when protection against oscillations is used as when compared with the ideal case where all the UEs are always connected to the optimal cell. In<sup>9</sup>, a ping-pong avoidance algorithm capable of effectively alleviating the unnecessary Vertical Handovers (VHO) between 3G cellular and WLAN hotspots was proposed. The algorithm determine the correct time at which a terminal should initiate a handover. It can be grouped into two major parts. Part 1 involves the setting up different VHO thresholds for the moving in and moving out scenarios. Part 2 involves the determination to executing VHO by adapting the mobility of the Mobile Terminal (MT) on the basisof the transition pattern estimation scheme for the RSS of the Wireless Local Area Network (WLAN) hotspots. The results show that the proposed VHO algorithm can greatly reduce unnecessary VHO. Performance degradation is highly prevented also because of decrease in service interruption time as result of unnecessary handover. In<sup>10</sup>, a novel vertical handover algorithm based on a probabilistic approach for decision strategy was presented. The technique treated the problem of using Wrong Decision Probability (WDP) assessment. This provides a trade-off between network performance optimization and reduction of the ping-pong handover effect. The WDP mechanism was evaluated using network parameters such as instantaneous estimated good put and the result show a good improvement interms of maximization of cumulative received bits andminimization of unwanted and unnecessary vertical handovers. As seen from all the cited literature, there is still room to explore a new method for load balancing and ping-pong handover control that has not been considered before now. The motivation of this research is to explore cell load and RSS to formulate and adaptive timer for load balancing and ping-pong control.

The rest of the paper is organized as follows. Section

2 presents our proposed distributed load balancing framework while Section 3 presents the decision variable formulations. In Section 4, we presented the detail flow chart of the decision algorithm. Presented in<sup>5</sup> are the simulation model and result analysis. We presented the paper’s conclusion in Section 6.

## 2. Proposed Distributed Load Balancing Decision Framework

LTE uses an E-UTRAN which is also based on a flat IP architecture. It comprises of eNBs, MME and System Architecture Evolution (SAE) gateway all designed to interoperate on the principle of SON architecture. As seen in Figure 2, the eNBs and MME/SAE gateway are linked together by the S1 interface.

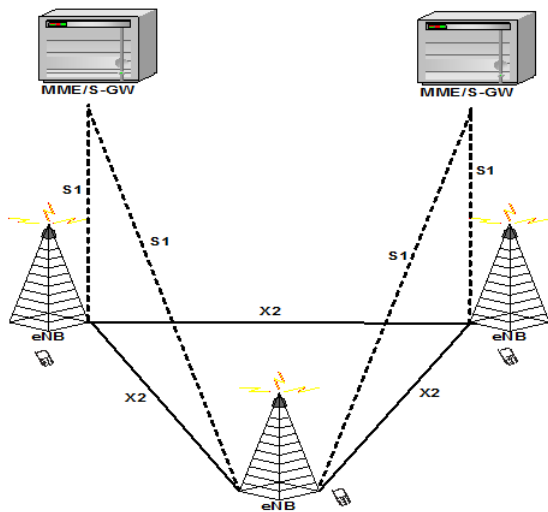


Figure 2. LTE system architecture.

The X2 interface link serves as the communication

medium between one eNB and another. Besides its function as the communication exchanger between adjacent eNBs, the X2 link is also responsible for the user plane when temporary user downlink data is to be sent during handover operation. As stated in the introduction section of the paper, load balancing related issues are SON use cases grouped by 3GPP to be handled within the area of self-optimization (optimization during the operational phase). In order to effectively implement our proposal, the three available SON architectures were carefully reviewed to propose the most suitable for this research. These are centralized SON, distributed SON and hybrid SON as seen in Figure 3.

The centralized SON has all the optimizing functionalities located in the Operation and Management (OAM). It is considerably easier to make expansion separate and for producers to deploy their own OAM systems. However, the possibility to optimizing the interaction of different equipment is very low. Also, simple and quick optimizing mechanisms are not maintained either. In the distributed SON, all the optimizing functionalities are located in each eNB. Despite the large amount of work and maintenance required during expansion and operation activities respectively, it is quite easy to accomplish challenges that involve only one or two eNBs with quick result success. For hybrid SON system, the simple and quick optimizing schemes are executed within the eNBs and the complicated ones are executed in the OAM. Optimizing the work between equipment of different producers through the X2 interface is achievable but not without the challenges of requiring many efforts during expansions. This is because of the need to adjusting each station and interaction interfaces between them. Due to the merits of the distributed SON architecture over others, we therefore adopt it for this research as its framework.

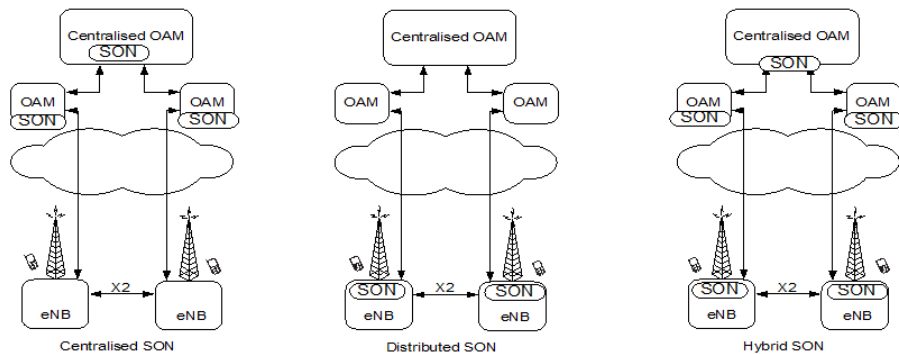
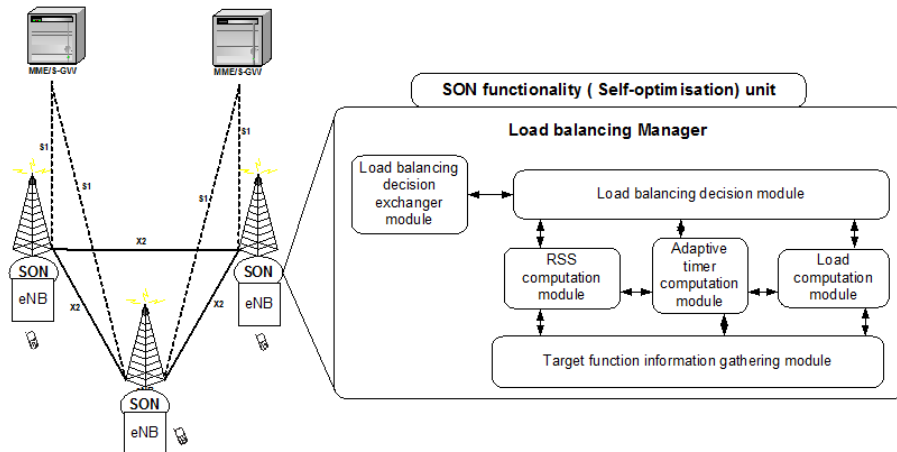


Figure 3. LTE SON architectures.



**Figure 4.** Proposed distributed load balancing decision framework.

The proposed framework is based on distributed SON architecture where the load balancing decision manager in the eNB resides as seen in Figure 4.

The SON functionality (self-optimization) unit houses the load balancing manager. Each sub-module details in the load balancing manager are:

### 2.1 Target Function Information Gathering Module

This section is responsible for the target function information collection and storing. Target information may also be directly derivable from the user's measurement report information data. Target functions in LTE system can be classified generally into capacity related and energy related targets. Capacity related target functions are concerned with issues like cell or network load, number of satisfied or unsatisfied users, cell or network throughputs, total or available Physical Resource Blocks (PRBs), etc. For energy related target functions, the concern will be on issues like RSS, power demand of users or eNBs, Signal to Noise and Interference Ratio (SNIR) etc. For this work, we consider RSS and cell load.

### 2.2 RSS Computation Module

RSS value of users is evaluated in this module based on the received measurement report from the users. The method used to compute RSS value in this paper is given in equation (1).

### 2.3 Load Computation Module

The cell load value is evaluated and stored in this module based on the received or read measurement report from

the eNB. The method used to compute cell load value in this paper is given in equation (5).

### 2.4 Adaptive Timer Computation Module

This module uses information from the target function information gathering module, RSS computation module and load computation module to determine the appropriate adaptive timer value to set for load balancing and ping-pong control. The computation detail for the purpose of this work is given in equations (6) and (7).

### 2.5 Load Balancing Decision Module

This module is the decision engine room based on the proposed algorithm given in Figure 3 for the purpose of this paper. The module gets its information from the RSS computation module, load computation module and the adaptive timer.

### 2.6 Load Balancing Decision Exchanger

Serves as the communication link that relays information between two or more eNBs. It uses X2 interface link for information exchange.

## 3. Decision Variable Formulations

In this research, formulations of the three main decision variables to execute our algorithm were given respectively. These variables are RSS, cell load and ping-pong adaptive timers. Explanation of each variable is given in the following subsections. The variables  $C$ ,  $U$ ,  $U_i$  in this work were used to represent the groups of cells, total users and

cell  $i$  users respectively. It is assumed that a connection function  $F_{i,u}(t)$  between a user and its serving cell exist.  $F_{i,u}(t)$  will be 1 (unity) when user  $u \in U$  and establishes its communications through cell  $i \in C$  at any instantaneous time  $t$  else, the value will be 0 (empty).

### 3.1 Received Signal Strength Formulation

RSS can simply be defined as the signal strength received by the user at a distance from the reference cell<sup>11</sup>. RSS is one of the key variables that can be used for handover decision making and its value depends on the user's distance or position from the cell<sup>12</sup>. It is proposed that each user should be connected to a cell (serving cell) that is able to provide it with the highest signal strength having considered the cell load to be in the acceptable load value. The evaluated RSS is however given higher priority over cell load if handing over to other neighboring cell cannot guarantee acceptable RSS value. The instantaneous RSS value received by a user  $u$  at a given distance from a cell  $i$  on PRB  $l$  at time  $t$  is formulated as shown in Equation 1:

$$RSS_{i,l,u}(t) = R_{i,l,u}(t) * T_p \tag{1}$$

Where  $R_{i,l,u}(t)$  is the overall instantaneous path loss between the user  $u$  on a physical resource block  $l$  and a reference cell  $i$  at a given time  $t$ ,  $T_p$  is the equal transmit power of the cell on each PRB.

### 3.2 Cell Load Formulation

For LTE systems, adjacent Orthogonal Frequency-Division Multiplexing (OFDM) subcarriers are grouped into PRBs through which each user is being served by the cell. Given the connection function between a user and a cell<sup>13</sup> and the total path loss between the user and the cell<sup>12</sup>, the Signal-to-Interference and Noise Ratio (SINR) on each PRB can easily be formulated. The definition for radio quality for each user is given as:

$$SINR_{i,l,u} = \frac{RSS_{i,l,u}(t)}{N + \sum_{j \in C, j \neq i} RSS_{i,l,u}(t) * T_p} \tag{2}$$

Where  $N$  is the thermal noise per PRB assumed to be same for all and  $R_{i,l,u}(t)$  is the overall instantaneous path loss between the user  $u$  on a physical resource block  $l$  and a reference cell  $j$  at a given time  $t$ .

The important aspect of equation (2) is the interaction of cell load with user's service requirements and the SINR within the cell. The cell load is defined as the fraction of used PRBs in the cell to the total number of the PRBs

allocated to the cell. Applying this definition, the load of cell  $i$  is given as:

$$\rho_i = \frac{\sum_{F_{i,u}(t)} PRB_{i,u}}{PRB_i} \tag{3}$$

Where  $PRB_{i,u}$  is the fraction of PRBs used by user  $u$  in cell  $i$  and  $PRB_i$  the total number of the PRBs allocated for cell  $i$ .

Through the application of Shannon's theorem, we can fulfill the Constant Bit Rate (CBR) requirement of data rate  $d_u$  of user  $u$ . Hence, the truly needed resources in terms of PRBs  $N_i$  by user  $u$  which depends on given  $SINR_{i,l,u}$  can be expressed as:

$$N_i = \frac{d_u}{R(SINR_{i,l,u})} \tag{4}$$

Using equation (4), we can better rewrite equation (3) with the consideration of not allowing the cell load to exceed 100% of its capacity as:

$$\rho_i = \min \left( 100\% - \frac{\sum_{F_{i,u}(t)} \frac{d_u}{R(SINR_{i,l,u})}}{PRB_i} \right) \tag{5}$$

### 3.3 Ping-Pong Adaptive Timer Formulation

The idea of mitigating ping-pong effect and load balancing in cellular network is not new in literature. It can be categorized broadly into two known as timing based approach and intelligence based approach. The timing based approach uses a set timer (fixed or adaptive) generally to initiate and execute ping-pong and/or load balancing control processes. The intelligent based approaches mostly involve the issue of proper decision making to optimizing one or more target functions such as RSS by user, cell throughput, cell load, number of satisfied users, SINR received by user, power consumption of cells and users, etc. In this paper, we adopt the timing based approach used in<sup>14</sup>. We particularly used RSS and cell load to formulate the two adaptive timers as shown in equations (7) and (9) respectively.

To formulate the adaptive timer value based on  $RSS_{TF}$  RSS timing factor  $RSS_{TF}$ , is firstly defined as:

$$RSS_{TF} = \frac{RSS_{target}}{RSS_{target} + RSS_{serving}} \tag{6}$$

Where  $RSS_{target}$  is the RSS from the target cell and  $RSS_{serving}$  is the RSS from the serving cell. The adaptive timer value based on RSS is therefore given as:

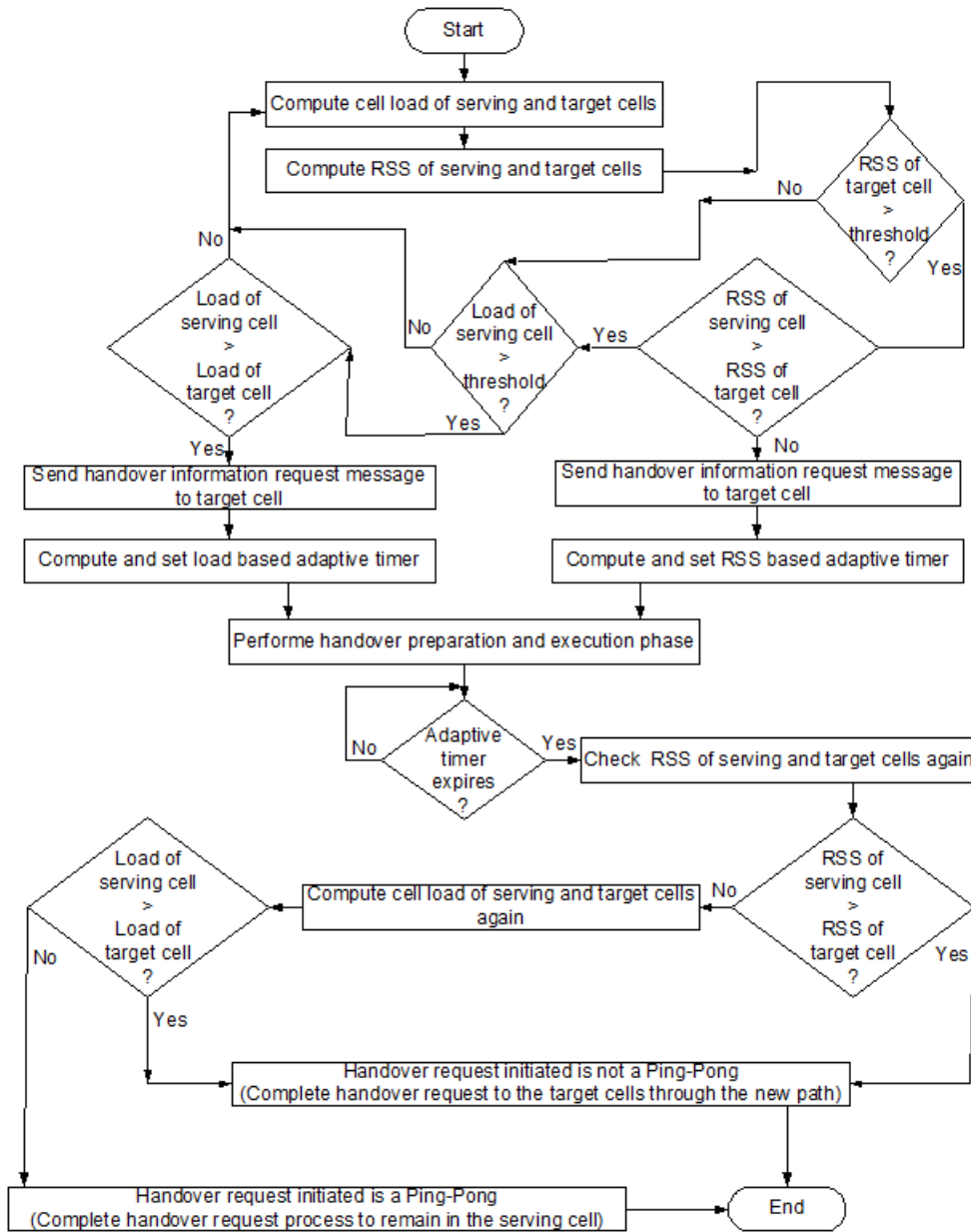


Figure 5. A dual-parameter adaptive timer decision algorithm.

$$T_{RSS} = Roundoff \left\{ Max \left[ Scale \left( 1 - \left( e^{-\left( 1 - RSS_{TF} \right)^P} \right), 1 \right) \right] \right\} \quad (7)$$

Where Round off is the operator to effect rounding off to the nearest integer, Scale defines the maximum value of the adaptive timer  $T_{RSS}$  and the exponent  $P$  gives the variation of  $T_{RSS}$  in terms of probability density function depending on the values of  $RSS_{target}$  and  $RSS_{serving}$  respectively. Similarly, the adaptive timer based of cell load  $T_{pi}$ , is given as:

For the adaptive timer value based on cell load  $T_{pi}$ , the loads timing factor  $pTF$  is firstly given as:

$$\rho_{TF} = \frac{\rho_{i_{serving}}}{\rho_{i_{target}} + \rho_{i_{serving}}} \quad (8)$$

Where  $pi_{target}$  is the cell load of the target cell and  $pi_{serving}$  is the cell load of the serving cell:

$$T_{pi} = Roundoff \left\{ Max \left[ Scale \left( 1 - \left( e^{-\left( 1 - \rho_{TF} \right)^P} \right), 1 \right) \right] \right\} \quad (9)$$

Where round off is the operator to effect round off to the nearest integer, Scale defines the maximum value of the adaptive timer  $T_{pi}$  and the exponent  $P$  gives the variation of  $T_{pi}$  in term of probability density function depending on the values of  $pi_{target}$  and  $pi_{serving}$  respectively.

## 4. Dual-Parameter Adaptive Timer Decision Algorithm

For easy and fast execution of the decision algorithm, the ping-pong and load balancing function requires the exchange of RSS and load profile information among the cells through the X2 interface link. In this research, two basic parameters (RSS and cell load) were used to tune set a handover timer that is adaptive by design. The detail algorithm flow is shown in Figure 5.

The algorithm uses two target functions (RSS of user and cell load values) to set the appropriate adaptive timer for the purpose of load balancing and ping-pong control. At the expiration of the set adaptive timer, a decision is made to load balance or not. If the handover request is not a ping-pong at the expiration of the adaptive timer, the load balancing should be completed and user is handed over to the best target cell through the new path. On the contrary, the handover request will be completed without handing over the user to any new cell by maintaining the old communication path.

## 5. Simulation Model and Result Analysis

### 5.1 Network Model used for Simulation

The idea proposed in this research can be applied to SON cellular networks of which LTE network is a typical candidate. For the purpose of computer simulation of this work, we considered a set of hexagonal LTE network as seen in Figure 6.

The network comprises of seven cells numbered 1, 2, 3, 4, 5, 6 and 7 respectively. Each cell is powered by a centrally placed eNB equipped with omni-directional antennas which covers its cell area and some other neighboring cell-edge users. In this typical scenario, cell 1 was made to have more users than its serving capacity and hence, termed over-loaded cell. Cell 2, cell 3, cell 4, cell 5, cell 6 and cell 7 are lightly-loaded and any of them can serve as a potential target cell for cell 1 edge-users for as

long as the user can receive adequate signal potency from the neighboring cell. If any cell is over-loaded and proper load balancing regime is not initiated and executed at the proper time, the cell will be challenged with poor service delivery, high handover failure and call blocking rate resulting to overall network degradation<sup>15</sup>. We assume cell and eNB to have the same meaning throughout this paper. Other assumptions in this research follow

- Users are randomly distributed in the cells and cell-edge users can also receive signal strength from its neighboring cell(s). RSS from serving and neighboring cells is periodically measured and reported through pilot measurements and reporting respectively.
- The smallest resource unit that can be assigned to each user is a PRB. A PRB comprises of twelve adjacent subcarriers that are grouped together as a resource unit for a user in a sub-frame time period of 1ms.
- All cells have equal power and each cell also allocates equal power to all the PRBs that are under its utilization respectively.
- The ping-pong detection timer to control the handover triggering process is designed to be adaptive. Its value should always be more than any sub-frame time.
- Load status information between neighboring cells are exchanged through the X2 interface link periodically in the network.

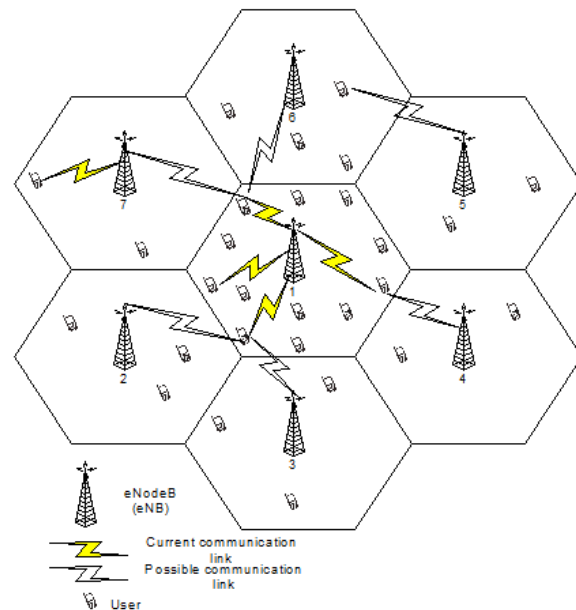


Figure 6. Network model used for simulation.



**Table 1.** Simulation parameters and value

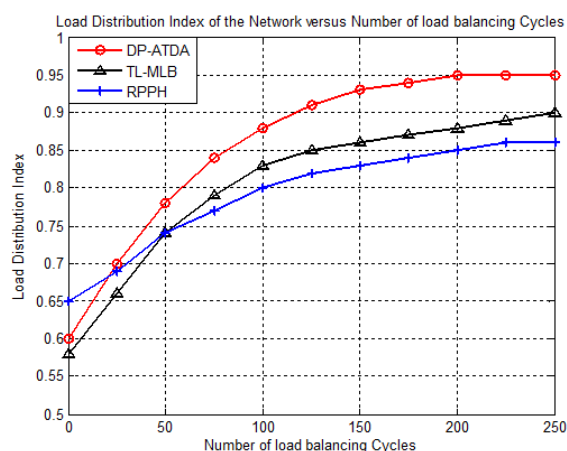
Parameter	Value
Network layout	Hexagonal grid
Cell radius	1 Km
Simulation duration	4 hours
User data rate	1 Mbps
Antenna type	Omnidirectional
eNB transmit power	46 dBm
Distance dependent path loss`	$128.15 + 37.6 \log_{10} d$ , $d$ is the distance between eNB and user measured in Km
Log-normal shadowing standard deviation	6.5 dB
System bandwidth	10 MHz (50 PRBs)
timing exponent $P$	8
Serving cell load $p_i$ threshold	0.8
Serving RSS threshold	-74 dB
Simulation periodic recall time	60 seconds
Measurement report time	400 msec
Sub-frame time	1 msec
Distribution in each cell	Uniform
Cell maximum capacity	20 users per cell
Total user units	140

The main simulation parameters used are given in Table 1 according to<sup>16-19</sup>. Each user is initially generated and allocated to its eNB in a random fashion according to Poisson arrival process. The life time of user was in the average of 2 minutes, tailored to be a random variable with negative exponential. The timing exponent  $P$  was taken as 8 according to<sup>4</sup> and the scale of the adaptive timer was set at 30 seconds. The simulation time was set for 4 hours with simulation periodic recalling time (load balancing cycle) at every 60 seconds. We assume data rate is 1 Mbps for every user. The relatively slow action of load balancing shows that long simulation time is required to properly understand its behavior.

## 5.2 Simulation Results

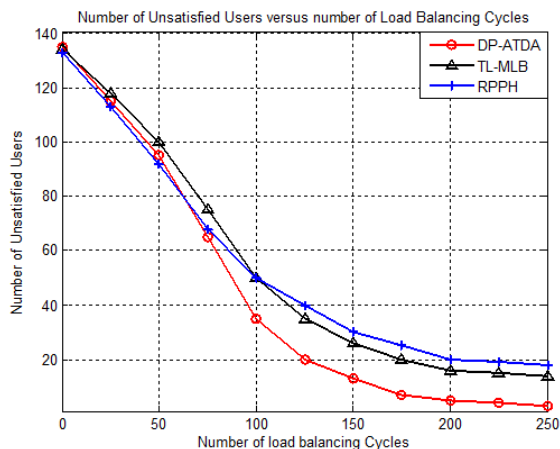
The simulation results in this sub-section show the performance of our research in terms of load balancing index, number of unsatisfied users, cumulative number of ping-pong handover request, cumulative number of non-ping-pong handover request and average throughputs of the cell. We compare our proposal named

DP-ATDA and two other references titled, a two-layer MBL (TL-MLB) presented in<sup>20</sup> and ping-pong handover reduction method (RPPH) presented in<sup>7</sup>. Figure 7 shows the load distribution index variation with the number load balancing cycles. The load distribution index is an indicator how the load is evenly distributed among the cells of the network. The more the cell load value is similar, the more the load distribution index is close to 1. For a network that is challenged with serious unbalanced load, the load distribution index will be reducing towards 0. This is expected because; load distribution index value is equal to the reciprocal of total number of cells in the network. A proper load balancing regime therefore should maximize the value of load distribution index as close to 1 as possible as the number of load balancing cycles increases. From the result plot, DP-ATDA gives the highest value of about 95% after 150 load balancing cycles followed by TL-MLB leaving the RPPH result with the least value. This achievement is possible because of the dual adaptive timer technique we adopted in this research that is able to seriously mitigate ping-pong effect on the network.

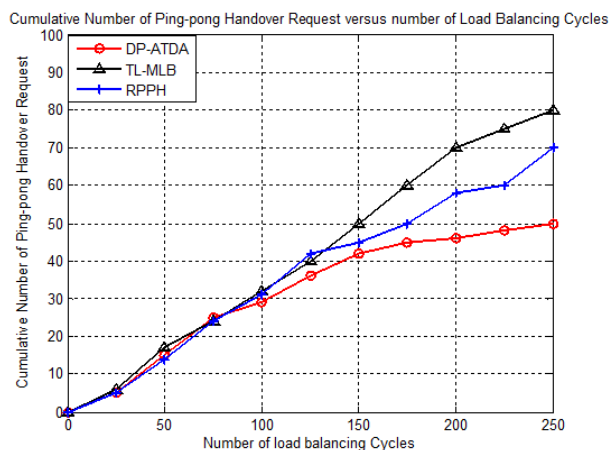


**Figure 7.** Load distribution index versus number of load balancing cycles.

Figure 8 gives the number of unsatisfied users versus load balancing cycles. From the plot, it is clear that DP-ATDA is better when compared with TL-MLB and RPPH respective. With our DP-ATDA, the number of unsatisfied users in the network reduces drastically to less than 20 users after about 150 load balancing cycles. When network load is balance at most times, user's satisfaction will definitely increase and that what this result clearly reflects.



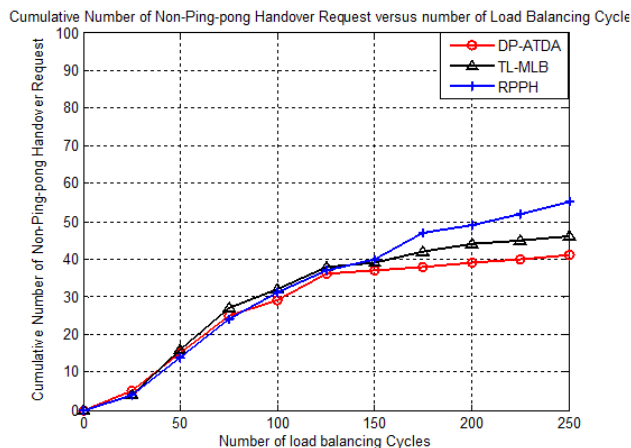
**Figure 8.** The number of unsatisfied users versus load balancing cycles.



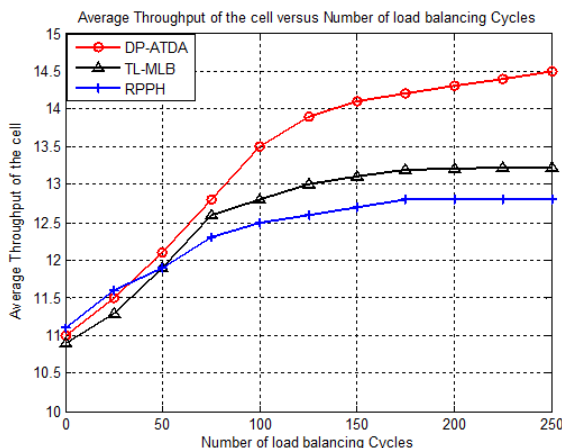
**Figure 9.** Cumulative number of ping-pong handover request versus load balancing cycles.

Figure 9 and Figure 10 show the cumulative number of ping-pong handover request versus load balancing cycles and the cumulative number of non-ping-pong handover request versus load balancing cycles respectively. Ping-pong handovers when not controlled can impact on the network seriously. It happens when user is switch back and forth between serving and target cell within a short period of time. Most times however, there is no need to execute this type of handover since the cause of its trigger could be temporary. The more the handovers, the more the network overhead with resultant impact on the quality of service and user experience. From the plot of Figure 9, DP-ATDA gives a much lower value when compared with TL-MLB and RPPH. The plot shows that at the 200th load balancing cycles, the cumulative number of ping-pong handover for DP-ATDA is less than 50 while that of RPPH and TL-MLB are close to 60 and 70 respectively.

Similarly, as seen in Figure 10, DP-ATDA gives a better result followed by TL-MLB while RPPH gives the least. The total handover request within for the simulated time is the sum total of the number of ping-pong handover request and that of non-ping-pong handover request. DP-ATDA is able to only allow the non-ping-pong handover request to be executed successfully and as such, we achieved improves the quality of service and average throughput as seen in Figure 11.



**Figure 10.** Cumulative number of non-ping-pong handover request versus load balancing cycles.



**Figure 11.** Average throughput of the cell versus load balancing cycles.

Figure 11 shows the average throughput of the cell versus load balancing cycles. The throughput value measured in Mbps is the sum of all users' data rate speed in the cell. As the load balancing cycle increases cumulatively, the average throughput of the cell should increase also since more users from congested cells who were previously unsatisfied are being load balanced to less

congested cells to get satisfaction. As seen in the plot, DP-ATDA is able to achieve more than 14 Mbps after 150 load balancing cycles while TL-MLB and RPPH achieved less than 13.5 and 13 Mbps respective for the same number of load balancing cycles considered. Higher cell throughput is one of the key performance indicators of a good load balancing algorithm. The figure obviously shows this that our proposal is better when compare with the two reference methods.

## 6. Conclusion

In this paper, we proposed a dual-parameter adaptive timer based decision algorithm for load balancing and ping-pong handover control in LTE network. The idea is build upon the SON distributed architecture due to its advantages. The decision algorithm is developed using adaptive timer to optimal manage the issues of load balancing and ping-pong handovers in the network. Two parameters (RSS and cell load) were considered for the development of the adaptive timer with the focus of choosing the best critical parameter at a time to calculate the adaptive timer. The algorithm is able to monitor ping-pong handover request and non-ping-pong handover request based on the evaluated adaptive timer to make appropriate load balancing decision. Computer simulations were done in terms of load balancing index, number of unsatisfied users, cumulative number of ping-pong handover request, cumulative number of non-ping-pong handover request and average throughputs of the cell. We achieved better performance over the two other reference methods in literature. Finally, our future improvement on load balancing in LTE network will adopt energy optimisation of relay transmission idea presented in paper<sup>21</sup>.

## 7. Acknowledgment

The authors would like to thank all those who contributed to making this research a success. We would like to gratefully acknowledge Research Management Center (RMC), Universiti Teknologi Malaysia for the financial support of this project under the research grant no: R. J130000.7809.4L632. We also acknowledge Federal University of Technology, P. M. B. 65, Minna, Niger State, Nigeria for approving the study fellowship for this research.

## 8. References

1. Carvalho M, Vieira P. An enhanced handover oscillation control algorithm in LTE Self-Optimizing networks. 14th International Symposium on Wireless Personal Multimedia Communications (WPMC); Brest; 2011 Oct 3-7. p. 1-5.
2. Marwat SNK, Meyer S, Weerawardane T, Goerg C. Congestion-aware handover in LTE systems for load balancing in transport network. ETRI Journal. 2014 Oct; 36(5):761-71.
3. Luan Y, Wang B, Lv ZB, Wang JQ. A novel optimizing mechanism of load balancing in LTE network. Proceedings of the 2nd International Conference on Computer and Information Application (ICCIA 2012); 2012. p. 1-4.
4. El Morabet F, El Moussaoui A, Aknin N. Adaptive handover time scheme for dynamic load balancing in LTE systems. International Conference on Multimedia Computing and Systems (ICMCS); Tangier. 2012 May 10-12. p. 578-82.
5. Honglin H, Jian Z, Xiaoying Z, Yang Y, Ping W. Self-configuration and self-optimization for LTE networks. IEEE Communications Magazine. 2010 Feb; 48(2):94-100.
6. Feher Z, Veres A, Heszberger Z. Ping-pong reduction using sub cell movement detection. IEEE 75th Vehicular Technology Conference (VTC Spring); Yokohama. 2012 May 6-9. p. 1-5.
7. Alradwan H, Motermawy A, Ghanem K. Reducing ping-pong handover effect in LTE mobile networks using TRIAS. Journal for Research and Scientific Studies Engineering Sciences series. 2011; 33(4):237-50.
8. Alonso-Rubio J. Self-optimization for handover oscillation control in LTE. IEEE Network Operations and Management Symposium (NOMS); Osaka. 2010. p. 950-3.
9. Kim WI, Lee BJ, Song JS, Shin YS. Ping-pong avoidance algorithm for vertical handover in wireless overlay networks. IEEE 66th Vehicular Technology Conference VTC-2007 Fall; Baltimore, MD. 2007 Sep 30-Oct 3. p. 1509-12.
10. Tamea G, Vegni AM, Inzerilli T, Cusani R. A probability based vertical handover approach to prevent ping-pong effect. 6th International Symposium on Wireless Communication Systems ISWCS 2009; Tuscany. 2009 Sep 7-10. p. 181-5.
11. Ahamed MM, Islam Z, Hossain S, Faruque S. LTE network coverage prediction for multi-traffic users in an urban area. IEEE International Conference on Electro/Information Technology (EIT); Rapid City, SD. 2013 May 9-13. p. 1-6.
12. Yildirim M, Alagoz F. WLC14-3: A new handover decision management algorithm in wireless overlay networks. Global Telecommunications Conference GLOBECOM '06; San Francisco, CA. 2006 Nov 27-Dec 1. p. 1-5.
13. Hao H, Xiangming W, Wei Z, Yong S, Bo W. Game theory based load balancing in self-optimizing wireless networks. The 2nd International Conference on Computer and Automation Engineering (ICCAE); Singapore. 2010 Feb 26-28. p. 415-8.
14. Huang YF, Gao FB, Hsu HC. Performance of an adaptive timer-based handoff scheme for wireless mobile communications. Proceedings of the 10th WSEAS International

- Conference on Signal Processing, Computational Geometry and Artificial Vision; 2010. p. 46–51.
15. Wang H, Liu N, Li Z, Wu P, Pan Z, You X. A unified algorithm for mobility load balancing in 3GPP LTE multi-cell networks. *Science China Information Sciences*. 2013 Feb; 56(2):1–11.
  16. Nathanie S, Syed Ariffin SH, Faisal N, Binti Ghazali NE, Khan AS. A cost function algorithm for mobility load balancing in long term evolution networks. *Australian Journal of Basic and Applied Sciences*. 2013 Jan; 7(7):742–54.
  17. Kwan R, Arnott R, Paterson R, Trivisonno R, Kubota M. On mobility load balancing for LTE systems. *IEEE 72nd Vehicular Technology Conference Fall (VTC 2010-Fall)*; Ottawa, ON. 2010 Sep 6-9. p. 1–5.
  18. Peng J, Hong P, Xue K, Tang H. A dynamic energy savings scheme based on enhanced mobility load balancing. *IEEE Vehicular Technology Conference (VTC Fall)*; Quebec City, QC. 2012 Sep 3-6. p. 1–5.
  19. Lee DW, Gil GT, Kim DH. A cost-based adaptive handover hysteresis scheme to minimize the handover failure rate in 3GPP LTE system. *EURASIP Journal on Wireless Communications and Networking-Special issue on adaptive cross-layer strategies for fourth generation wireless*. 2010 Feb; 2010; 6.
  20. Zhang L, Liu Y, Zhang M, Jia S, Duan X. A two-layer mobility load balancing in LTE self-organization networks. *IEEE 13th International Conference on Communication Technology (ICCT)*; Jinan. 2011 Sep 25-28. p. 925–9.
  21. Priyanka SS, Vetrivelan P. Optimizing energy in relay transmission schemes in LTE-A networks. *Indian Journal of Science and Technology*. 2015 Aug; 8(20):1–7.