

Human Vital Physiological Parameters Monitoring: A Wireless Body Area Technology Based Internet of Things

Aliyu Ahmed, Ajao Lukman Adewale^{*)}, Agajo James, Olaniy Olayemi Mikail, Buhari Ugbede Umar, Emmanuel Samuel

Department of Computer Engineering, School of Electrical Engineering and Technology, Federal University of Technology, Minna, Nigeria

Citation: A. Ahmed, A. L. Adewale, A. James, et al. "Human Vital Physiological Parameters Monitoring: A Wireless Body Area Technology Based Internet of Things," Jurnal Teknologi dan Sistem Komputer, vol. 6, no. 3, Jul. 2018. doi: 10.14710/jtsiskom.6.3.2018.115-121, [Online].

Abstract – Human vital physiological parameters (HVPP) monitoring with embedded sensors integration has improved the smart system technology in this era of a ubiquitous platform. Several IoT-based healthcare applications have been proposed for remote health monitoring. Most of the devices developed require one on one contact with doctors before any medical diagnosis is undertaken which make it difficult for frequent visitation to the health center. In this paper, embedded heartbeat and temperature sensors for remote monitoring have been developed using Arduino lily as the system controller and processing unit. The Bluetooth low power enables with Android mobile apps is used for remote monitoring and communication of HVPP in a real time. This gives medical personnel and individual customers opportunity of monitoring their vital physiological parameters such as heartbeat rate and body temperature. However, it moderates sudden attack of chronic ailment like hypertension and reduces congestion of patient in the hospitals.

Keywords – Arduino lily; Bluetooth integration; embedded sensors; human vital physiological parameters; hypertension monitoring

I. INTRODUCTION

Monitoring of human vital physiological parameters remotely has been an issue for medical expert and peoples over the years. This is as a result of some chronic diseases that are deadly (like heart attack, hypertension, and stroke) which require regular check-up. Also, some health vital sign of illness can threaten the medical patients and lead to sudden death if proper monitoring is not undertaken. This HVPP includes human body temperature, heartbeat/pulse rate, and blood pressure. Therefore, medical health monitoring system utilized the different type of biomedical sensors for continuous nursing or watching of various human body physiological parameters in real time.

A wireless body area networks (WBAN) can be described as an application-specific tool for monitoring

human body health system. This WBAN is specially designed to function autonomously with the integration of embedded chips in a medical organization. This devices (WBAN) can be positioned at both confidential and open-air of a human body (embedded or on-body respectively) [1]. This WBAN technology in pervasive era provides numerous advantages which are portability, mobility, flexibility, location self-governing and cost saving to both the medical personnel and patients. WBAN is a self-independent that made up from embedded sensor and wireless technology based internet of things.

Internet of Things (IoT) is a universal system that is distributed over a network for data computation, sharing of resources and communication exists between several devices like mechatronics system (robots), digital electronics system (phones), objects, animals or peoples that are identified with a unique code [2]. A thing, in the IoT, can be described as individual with implanted heart monitor device or WBAN, grange animal with embedded bio-chip transmitter, or an automobile inbuilt sensors for driver alert which assigned with a unique IP address for communication over a network.

This advancement in technology has contributed immensely to healthcare management with modern intensive care units (MICU) that depends on the pervasive network using a 6LowPAN platform. It gives an opportunity to the variety of sophisticated instruments to be manufactured for a broad range of human physiological state measurements and monitoring using Bluetooth Low Energy (BLE), Wi-Fi, Z-wave, ZigBee or RFID as the state-of-the-art medium for transmission of medical data [3]. The fast growth of wireless devices has improved the medical data computation, remote patient monitoring (human health vital signs) and diagnosis using Android-based mobile technology [4].

Human hypertension is discussed in [5] as the most common threat to an individual living soul, specifically human in pregnancy (HIP), obesity human (OH), and patients with a diabetic ailment. It is substantiated by World Health Organization (WHO) in 2012 that more than two pregnant women were identified with hypertension complaint daily. Therefore, the early detection or diagnosis of human illness like

^{*)} Corresponding Author (Ajao Lukman Adewale)
Email: ajao.wale@futminna.edu.ng

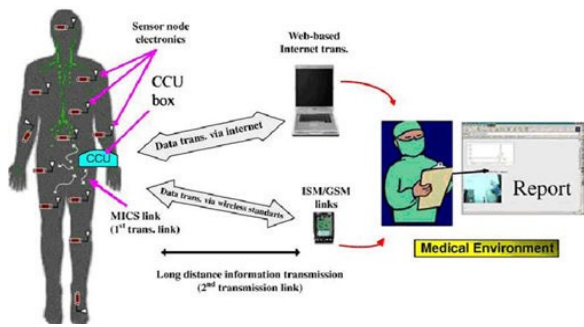

Figure 1. Implementation of wireless body sensor prototype [8]

cardiovascular disease or hypertension can reduce the total estimate of patient treatment, prolong life expectancy and quality of life [6]. It is observed and estimated that due to the inadequacy of health care center, about 85% cost is incurred on patient health treatments, sickbay, and others while 4% was spent on diagnosing patient illness [7]. The architecture of WSN for health monitoring is shown in Figure 1.

Health monitoring and management system using the internet of things for remote sensing with cloud-based processing, opportunity, and challenges were thoroughly discussed by [9]. The IoT-based model for remote patient monitoring using (IEEE.802.15.4) and sensor array for measuring EKG, SpO2 and body temperature was proposed by [10]. This model supports a physician to monitor the patients' health condition remotely which includes body temperature, heartbeat rate and so on. An efficient large-scale data transmission for healthcare architecture was proposed in [11] called IoT-based remote health monitoring system for the smart region (IReHMo). The system is capable of incorporating several types of home automation sensors and health-care based IoT devices for the sensing layer to improve the bandwidth and reduced volume of data generated in the cloud services.

One slave unit device using ZigBee technology is developed for patients monitoring system [12]-[15]. This includes heart rate/ECG, temperature, blood pressure, pulse rate and so on. Tikate et al [12] mounted a slave unit on every patient sick bed to monitoring and transmitting data about the patient health in the hospital. The shortcoming of the system model in biomedical data transmission with central monitoring system are restriction of patient monitoring within the health center and limitation of data access to the only nurse on duty.

UHC monitoring system based on mobile elderly health was proposed by [16] using Bluetooth technology and smartphone with an accelerometer as Intelligent Central Node (ICN). This architecture provides accessibility to family members and medical authority awareness of patient health status via the internet. Wagh and Rajankar [17] presented wireless body area network-based sensor to provide steady, timely, comfortable and proper monitoring of physical and biomedical parameters of the patient continuously.

Table 1. Heartbeat rate with various patient categories (22-75) years

No	Patient categories (years)	Heartbeat rate (s ⁻¹)
1	Infant age < 2	100-160
2	Older children 2-10	90-110
3	Teenage children >10	60-110
4	Adult < 20	60-110
5	Active athletes	40-60
	Average heartbeat by sex	
6	Male	70
7	Female	75

Therefore, a remote health monitoring system for human physiological parameters like temperature, humidity, pressure and heartbeat/pulse rate over a distance was developed in this paper using Bluetooth like [16]. Unlike previous research, this system allows a patient to monitor the vital health parameters by an Android mobile phone and transmitting the data to a central health database to be analyzed by a doctor later. This system was tested and implemented with at least 50 different patients at Federal University of Technology Health Center, Minna, Nigeria. According to the American Heart Association in 2012, a human heartbeat rate in its normal form should be in the range of 60-100 beats per minutes (BPM). While some heartbeat rates are considered fast (Arrhythmia), others were regarded as slow (Bradycardia) heartbeat rates. For reference purposes in this research, Table 1 presents the values of heartbeat rates with respect to different categories of patients.

II. RESEARCH METHODS

The development of human vital physiological parameter monitoring system based on the internet of things consists of both hardware design and software programming. The hardware design is mainly on single-on-chip (SoC) microcontroller that capable of connecting individual sensors, low energy consumption wireless technology (Bluetooth) and power supply unit (using lithium battery) which can serve for a long-term before replacement or recharging. The software program design is implemented using Arduino IDE and Eclipse software for the development of an Android mobile application. This graphic user interface (GUI) of Android mobile apps will allow the patient and doctor to access information about body physiological parameters remotely. The block diagram of the system architecture is depicted in Figure 2.

The pulse sensor signal and patient temperature are processed by the microcontroller which used in measuring, analyzing and interpreting the signals before transmits to the mobile Apps via Bluetooth module. The integration of GSM module network or a WLAN, in turn, sends the received data to a cloud database, where the doctor can conveniently access all patients' records in real time.

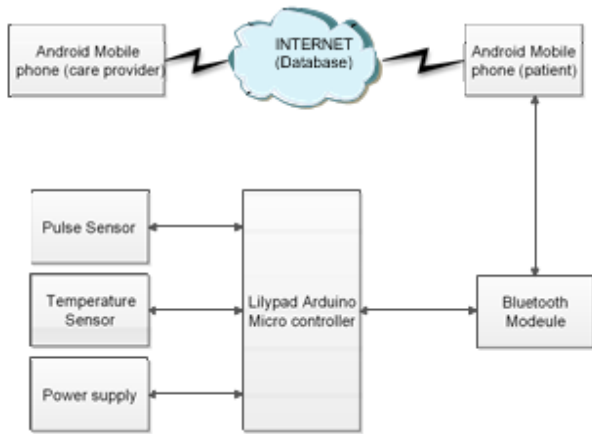

Figure 2. A wireless body area network block diagram

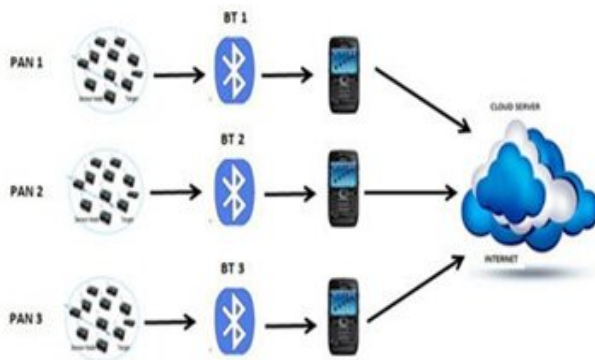

Figure 3. Wireless body area network conceptual model

A. Wireless Body Area Network Model

The WBAN model is a remote health patient monitoring or health insurance system that is available for remote human health physiological parameter monitoring like human body temperature, pressure, and pulse rate/heartbeat. This model is conceptually illustrated as given in Figure 3. It consists of wireless body sensor nodes, which deployed for human physiological parameters acquisition and monitoring, wireless technology based IoT are used for data transmission (low power enable Bluetooth and GSM module) and the cloud database.

The total number of sensors deployed for monitoring and acquisition of different human physiological parameters, S_{total} is given as Equation 1. S_{PAN} is sensor nodes deployed to monitoring physiological parameters within human body and n is the sensor node density. Thus, the characteristic equation is expressed as in Equation 2. S , BT , and D_{loc} denote sensors, Bluetooth base station for wireless body area network and database location respectively. The characteristic equation is expressed as in Equation 3.

$$S_{total} = \sum_{i=1}^n S_{PAN} \quad (1)$$

$$CE = [S]^T [BT] = [D_{loc}] \quad (2)$$

$$\begin{bmatrix} S_{11} & S_{12} & S_{13} & S_{14} \\ S_{21} & S_{22} & S_{23} & S_{24} \\ S_{31} & S_{32} & S_{33} & S_{34} \\ S_{41} & S_{42} & S_{43} & S_{44} \end{bmatrix}^T \begin{bmatrix} BT_1 \\ BT_2 \\ BT_3 \\ BT_4 \end{bmatrix} = \begin{bmatrix} D_{loc1} \\ D_{loc2} \\ D_{loc3} \\ D_{loc4} \end{bmatrix} \quad (3)$$

The database location is the point where the measured parameter is going to be domiciled in the web server database. The eventual function is represented as in Equation 4. Thus, the equation for 50 different patient bodies with 4 parameters to be measured is given in Equation 5. The + sign in the equations represent add up from the personal area network PAN, within the patient's body and N represent the last number of patient used in the experimentation.

$$F(S, BT, D_{loc}) = S_1 BT_1 + S_2 BT_2 + \dots + S_n BT_n \quad (4)$$

$$\begin{aligned} S_{11} BT_1 + S_{12} BT_2 + S_{13} BT_3 + \dots + S_{1n} BT_n &= D_{loc1} \\ S_{21} BT_1 + S_{22} BT_2 + S_{23} BT_3 + \dots + S_{2n} BT_n &= D_{loc2} \\ S_{31} BT_1 + S_{32} BT_2 + S_{33} BT_3 + \dots + S_{3n} BT_n &= D_{loc3} \\ S_{41} BT_1 + S_{42} BT_2 + S_{43} BT_3 + \dots + S_{4n} BT_n &= D_{loc4} \\ &\vdots \\ S_{n1} BT_1 + S_{n2} BT_2 + S_{n3} BT_3 + \dots + S_{nn} BT_n &= D_{locN} \end{aligned} \quad (5)$$

The flowchart operation of this Wi-Medicare developed system is illustrated in Figure 4. It includes data reading from temperature and pulse sensors, connection initiation to Android phone via Bluetooth, data transmission to phone and to a central database via Internet. A doctor can analyze the patient data using an Android phone.

B. Wireless Body Area Sensing Unit

This module consists of different wireless body sensors which implemented for the physiological patient parameter monitoring like SEN 11574 pulse/heartbeat sensor and DHT11 temperature sensors are used in this work. The architecture of pulse/heartbeat rate sensor is illustrated in Figure 5, which is designed for Arduino as a plug and play device. The pulse sensor consists of an embedded microchip front and back view that makes contact with the human skin for reading purposes. The front view includes a small hole with LED indicator and a square underneath for ambient light sensor. This sensor is connected to the Arduino with the aid of three wires: power (VCC), ground (GND), and the signal line.

The DHT 11 sensor is calibrated with a digital signal output for both temperature and humidity to receive about 3.5-5.5V for power. When power is supplied to the sensor, a tolerance of at least one second is given to the sensor in it order to pass unstable status before any instruction is sent to it.

C. Wireless Body Area Transmission Unit

This unit helps in the transmission of physiological parameters acquired from patient body area network to

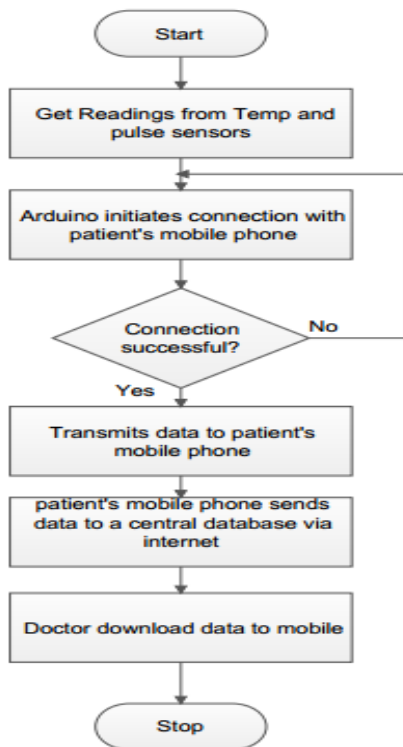

Figure 4. A flow chart operation of the developed wireless body area system

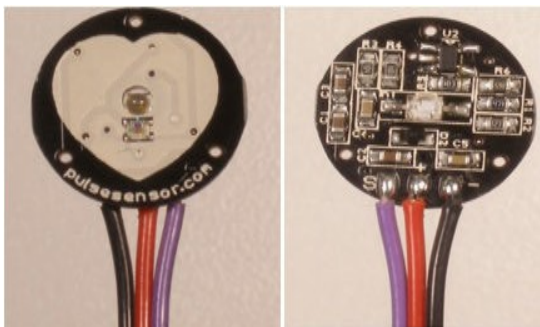

Figure 5. Embedded heartbeat sensor architecture

the cloud database. This module includes a wireless serial port of 4-pin HC-06 transceiver Bluetooth module, which is connected to the receiver (RX) and transmitter (TX) pins of the microcontroller to enable sending of data to the designated recipient mobile phone for transmission and communication to the medical patient diagnostic (doctor). The architecture of Bluetooth module is illustrated in Figure 6. This module is cost effective, readily available and scalable. The four pins of the Bluetooth module include the power (VCC) connected to the 5V of the microcontroller, ground (GND) pin, transmission pin (TXD) used to send data from the module to Arduino and a receiver pin (RXD) used to receive data from the Arduino.

This system used the Bluetooth module for data transmission at the rate of 1Mbits/s. This device covers a distance range of 0-10 meters apart and operating at the frequency of 2.4 GHz with pairing time of 10 seconds or less. Bluetooth utilizes E0 stream cipher with

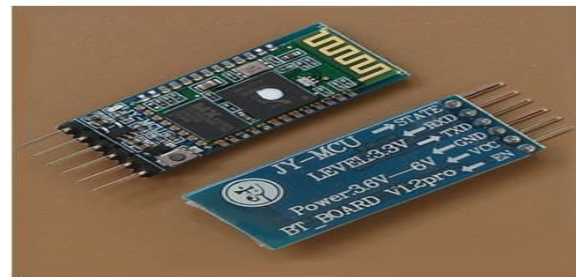

Figure 6. Architecture of (HC-06) Bluetooth low energy Tx/Rx module



Figure 7. Patient registering graphic user interface

16-bit cyclic redundancy check (CRC) shared which request for a passkey during the connection attempt. The Bluetooth transmission time for this research work is calculated as expressed in Equation 6. T_t is data transmission time, d_s is data size, P_{smax} is maximum payload size, O_s is overhead size, B is bit rate and P_t is propagation time between the connecting devices.

$$T_t = \left(d_s + \left(\frac{d_s}{P_{smax} * O_s} \right) \right) B + P_t \quad (6)$$

D. Software System Development

An android mobile web application is designed as a graphical user interface (GUI) for patients and medical dashboard for any related physiological parameters acquired from the wearable health device. The software programming was designed using Eclipse Kepler IDE integrated with the Android SDK. Also, a dedicated online database where patients' data are stored for future diagnosis is developed as an interface for patients physiological parameters detail as depicted in Figure 7.

Table 2. Heartbeat rate and temperature results obtained from the patient between (22-65) years

Patient	Average of heartbeat per-minute			Average reading temperature (°C)		
	developed system	collected data	Deviation, %	Developed system	Collected data	Deviation, %
1	76	75	1.30	32	32	0
2	73	72	1.37	32	32	0
3	82	81	1.22	34	33	2.94
4	69	69	0	33	32	3.03
5	80	80	0	33	32	3.03
6	85	84	1.18	32	32	0
7	77	76	1.29	31	31	0
8	79	79	0	33	32	3.03
9	76	75	1.32	33	33	0
10	70	70	0	32	32	0
11	65	65	0	28	28	0
12	63	63	0	28	28	0
13	65	65	0	29	29	0
14	65	65	0	28	28	0
15	67	67	0	29	29	0
16	63	63	0	29	29	0
17	60	60	0	30	30	0
18	61	61	0	29	29	0
19	50	50	0	31	31	0
20	52	52	0	31	31	0

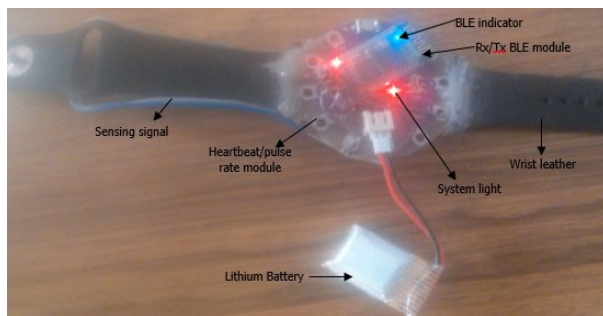

Figure 8. Complete and functioning prototype design of wearable health monitoring

III. RESULTS AND DISCUSSION

The developed system prototype is tested and is working effectively as depicted in Figure 8. Temperature and heartbeat sensors, a Bluetooth module, and the system indicators are deployed in the prototype. It used a Lithium battery to operate.

The database platform used is 'biz.nf.co' for the development of Android web app which provides a capacity for data storage of about 1000 MB. The database is capable of holding various data varies from blood pressure, heartbeat rate, temperature, oxygen and water level, patients biometrics and medical histories. The database is secured and restrict accessed to health administrator, doctor and any authorized users. The developed and functioning dashboard responsible for the display of human physiological parameters is depicted in Figure 9.

The wearable wireless body area system developed is tested with at least 50 patients at Federal University of Technology health center, Minna, but 20 data are

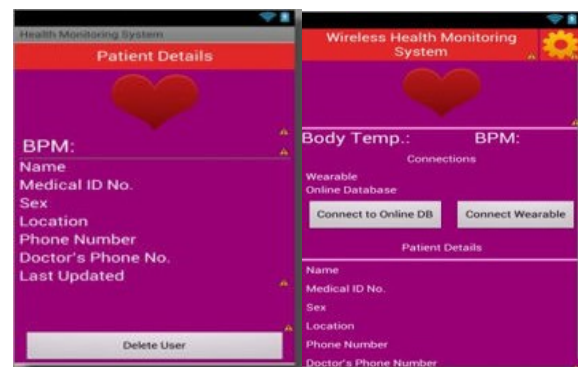

Figure 9. Human health physiological parameters GUI

presented here. The device seems portable, efficient, accurate and cost effective with result acquired during testing of patient heartbeat rate and temperature as presented in Table 2, for the available ages between (22-65) years patients in the health center. The percentage deviation is calculated as given in Equation 7 where %d is percentage deviation heartbeat health data, α_d is clinic health data and β_d is prototype testing data.

$$\%_d = \left(\frac{\alpha_d - \beta_d}{\alpha_d} \right) \quad (7)$$

Figure 10 illustrates the graphical results of heartbeat rate and temperature readings. The research results analysis of heartbeat rate in bit per seconds (bps) and temperature in degree Celsius (°C) from the experimental system developed are analyzed in Table 2 which outline different cases of men hearth rate range and temperature from 36-65 years. The experimental

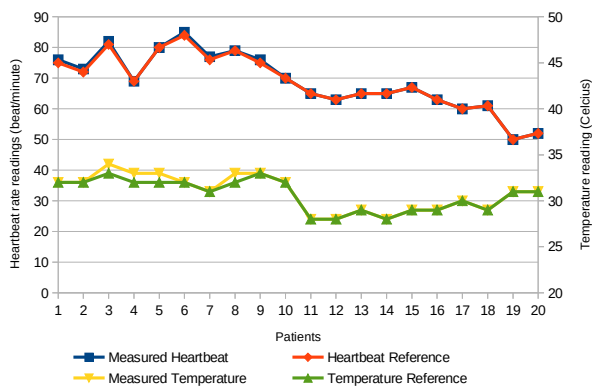

Figure 10. Graph of heartbeat rate and temperature against patients

results for the first three rows were conducted around 1:30 pm for clerical and cleaner women of 47-60 years. This shows that their heartbeat rate is averagely OK, and is due to some factors surrounding them such as environmental condition (temperature), stress at work and so on. From 4th row to the 10th row was conducted for men of 30-65 years age at afternoon period. The result of heartbeat rate shows that is below average. It is discovered that this set of people diagnose are been vulnerable to hypertension ailment, due to their working altitude, environment and stress incurred at work. It is advisable that special care and attention of management is required to rescue the situation.

Also, results presented in Table 2 from 11th row to 15th row shows the heartbeat rate of an academic staff of university between 37-60 years. The heartbeat results is normal (Good). It may as the result of office environment that range from 28-29°C temperature, pressure and stress are minimal. Therefore, it is good for the workers' health condition. From 16th-18th rows shows the diagnose heartbeat condition in women between age of 40-58 years in the offices. The heartbeat result found to be excellent under the temperature of 28-30°C, and no tension or threat of hypertension if working condition and stress are kept constant. Finally, an athlete men was also diagnosed using the developed system and the result read 50-54 bpm at a temperature of 31°C. It indicates a healthy condition with normal exercises required.

This research has developed a wireless body area system with both hardware and software integration for HVPP monitoring. It has a good accuracy in reading temperature and heartbeat at above 96,9% of accuracy (Table 2). A wireless sensor module from electronic materials integrated with an Android mobile application as [4], but this integration in this research was used as control interface for real time interactions between a patient, the doctors and the healthcare provider. The wireless technology (both sensors and networks) are very important because it helps both physician and patient to monitor vital health parameters remotely from the Internet via a Bluetooth module as used in [16], [17]. It assists individual to know about current health challenges based on heartbeat rate and body

temperature. Among the gains of these technologies is the improvement on the quality of life [5]-[7], time-consuming during visitation to the health center for check-up and at the same time bring the issue of cost to its minimum as indicated in [1]-[4], [9].

IV. CONCLUSIONS

This developed wireless body area system performed good performance in terms of sensitivity, accuracy and response time as well as provided better interaction between a patient and the health care provider using Android interface. Future work includes adding more features to extend the ability to sense more human physiological data by considered transmission time, occupation rate and efficiency of the database. Also, alarm system can be included to alert the patient in case of an abnormal physiological parameter readings.

ACKNOWLEDGMENT

This work was supported by the Department of Computer Engineering and Health Center Unit, Federal University of Technology, Minna, Nigeria. We appreciate the management of university for providing the funds and adequate research laboratory.

REFERENCES

- [1] J. Y. Khan and M. R. Yuce, "Wireless Body Area Network for Medical Applications," In *New Development in Biomedical Engineering*, InTech, 2010, pp. 591-628.
- [2] A. A. Lukman, A. J. Agajo, K. J. Gana, et al. "Development of A Low Power Consumption Smart Embedded Wireless Sensor Network for the Ubiquitous Environmental Monitoring using Zigbee Module," *ATBU Journal of Science and Technology Education*, vol. 5, no. 1, pp. 94-108, 2017.
- [3] L. A. Ajao, J. Agajo, J. G. Kolo, et al. "Wireless Sensor Networks Based-Internet of Thing for Agro-Climatic Parameters Monitoring and Real-Time Data Acquisition," *Journal of Asian Scientific Research*, vol. 7, no. 6, pp. 240-252, 2017.
- [4] A. V. Mbakop, A. Lambebo, A. Jayatilleke, and S. Haghani, "Implementation of A Wireless Body Area Network for Healthcare Monitoring," in *ASEE-American Society for Engineering Education*, 2013.
- [5] I. Z. Jibril, J. Agajo, L. A. Ajao, et al. "Development of a Medical Expert System for Hypertensive Patients Diagnosis: A Knowledge-Based Rules," *Advances in Electrical and Telecommunication Engineering (AETE)*, vol. 1, no. 1, pp. 39-47, 2018.
- [6] C. Otto, "An Implementation of a Wireless Body Area Network for Ambulatory Health Monitoring," M.S. thesis, University of Alabama, Huntsville, 2006.

- [7] M. A. Eneji, V. J. Dickson, and B. J. Onabe, "Health Care Expenditure, Health Status and National Productivity in Nigeria," *Journal of Economics and International Finance*, vol. 5, no. 7, pp. 258-272, 2013.
- [8] S. N. Ramli and R. Ahmad, "Surveying The Wireless Body Area Network in the Realm of Wireless Communication," in *2011 7th International Conference on Information Assurance and Security (IAS)*, Melaka, Malaysia, Dec. 2011, pp. 58-61.
- [9] H. Moeen, A. Page, T. Soyata, et al. "Health Monitoring and Management Using Internet of Things (IoT) Sensing with Cloud Based Processing: Opportunities and Challenges," in *2015 IEEE International Conference on Services Computing*, New York, USA, July 2015, pp. 285-292.
- [10] A. Archip, N. Botezatu, E. Serban, et al. "An Internet of Things Based System for Remote Patient Monitoring," in *2016 17th IEEE International Carpathian Control Conference*, Tatranska Lomnica, Slovakia, June 2016, pp. 1-6.
- [11] N. M. Khoi, S. Saguna, K. Mitra, et al. "IReHMo: An Efficient Internet of Things-Based Remote Health Monitoring System for Smart Regions," in *2015 17th International Conference on E-health Networking, Application & Services (HealthCom)*, Boston, USA, Oct. 2015.
- [12] M. D. Tikate, R. P. Yenare, D. P. Thakkar, et al. "Biomedical Data Transmission System with Central Monitoring," *International Journal of Scientific Research and Engineering Studies (IJSRES)*, vol. 2, no. 2, pp. 91-95, 2015.
- [13] J. Agajo, N. Bello, F. Ntekim, et al. "Zigbee Based Wireless Patient Temperature and Pulse Monitoring System," *Journal of Wireless Sensor Networks*, vol. 3, no. 1, pp. 1-16, 2016.
- [14] K. Navya and M. B. R. Murthy, "A Zigbee Based Patient Health Monitoring System," *International Journal of Engineering Research and Applications*, vol. 3, no. 5, pp. 483-486, 2013.
- [15] T. Chandrasekhar, J. S. Charavarthi, and V. Srikanh, "Wireless Health Monitoring System using Zigbee," *International Journal of Innovative Research in Science, Engineering and Technology*, vol. 2, no. 11, pp. 7021-7026, 2013.
- [16] A. Bourouis, M. Feham and A. Bouchachia, "Ubiquitous Mobile Health Monitoring System for Elderly (UMHMSE)," *International Journal of Computer Science & Information Technology (IJCSIT)*, vol. 3, no. 3, pp. 74-82, 2011.
- [17] K. P. Wagh and S. O. Rajankar, "Wireless Body Area Network: Real-Time Health Monitoring System," in *IJCA Proceedings on National Conference on Advancement in Electronics and Telecommunication Engineering*, vol. 1, May 2012.