

DESIGN AND CONSTRUCTION OF A DIGITAL WEIGHT SCALE

BY

**KIKELOMO .A. DANIEL
99/8137EE**

**Department of Electrical/Computer Engineering
School Of Engineering and Engineering Technology
Federal University of Technology, Minna
Niger State, Nigeria.**

**A Project Report Submitted In Partial Fulfillment For
The Award Of Bachelor Of Engineering Degree (B.Eng.)
In Electrical/Computer Engineering**

NOVEMBER 2005

CERTIFICATION

This is to certify that this project "Design and Construction of a digital weight scale" was designed and constructed by KIKELOMO .A. DANIEL as a requirement for the award of bachelor degree in Electrical/Computer Engineering of the Federal University of Technology, Minna, Niger State, Nigeria.

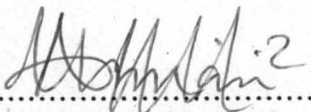

.....
Mr. Abraham. U. Usman
PROJECT SUPERVISOR

6TH DEC, 2005
.....
DATE

.....
Engr. Musa. D. Abdullahi
HEAD OF DEPARTMENT

.....
DATE

.....
EXTERNAL EXAMINER

.....
DATE

ACKNOWLEDGEMENT

I sincerely acknowledge and appreciate the Lord, my Creator and Sustainer for his grace and love that has made my life possible and worth living.

I acknowledge my parents, Dr. and Mrs. Daniel for their unflinching support and many prayers, my siblings Shade, Yejide, Damilola and Seun for making home a place of great warmth and laughter, and Goke for being my blessing.

I acknowledge the efforts and contributions of all my lecturers these five sessions in F.U.T. especially my supervisor Mr. Abraham. U. Usman for his invaluable contributions and aid in carrying out this project. Worthy of mention is Engr. Musa. D. Abdullahi who endeared himself to students hearts with his leadership as HOD of the Electrical department.

Fellowship of Christian students and her leadership of whom I was privileged to have been a part has my love and honor. I thank every member for their support and concern all through my stay in F.U.T.

I appreciate the innumerable friends and connections that I have acquired here. I dare not begin to mention names of those in school and so many others who are no longer in F.U.T., it will be a long list of men and women of influence. I am improved and made rich because of you all. I value and appreciate our friendship. Thanks you.

Finally, I must say thanks a million to Joseph Jones Agunbiade and Seun Ajagbe for their ingenious expertise and to Simeon Agada for the ceaseless use of his room and system.

God bless you all.

DEDICATION

This project is dedicated to all who are determined to beat the odds and make positive impact in this generation.

ABSTRACT

Measurement is an age old concept to man. Accurate measurement of human weight has become of utmost importance in this age where a number of health conditions can be tied to excess weight. This project discusses out the construction of a digital weight scale bearing in mind cost effectiveness, locally available components and portability without undermining sensitivity.

The load balance system used is similar to that of any analog bathroom scale as this system has been proven to be reliable and convenient over time. A potentiometer is attached to the spring controlled lever in the load balance system. This potentiometer serves as a sensor converting the mechanical movement to a proportional voltage output. This output voltage is converted by an analog to digital converter IC to its digital equivalent which is then manipulated to be displayed on the seven segment digit display. The value displayed is the weight of the person on the platform (cover) of the scale.

The construction was as desired though the results obtained were at variance with the anticipated results. It functions well for human weight measurement.

TABLE OF CONTENT

	Page
Title page	i
Certification	ii
Acknowledgement	iii
Dedication	iv
Abstract	v
Table of Content	vi
CHAPTER ONE	
1.1. Introduction	1
1.2. Advantages of digital systems over analog systems	2
1.3. Aims and Objectives	2
1.4. General description of a measuring system	3
CHAPTER TWO	
2.1. Literature Review	5
2.1.1. The Analog Weight Scale	6
CHAPTER THREE	
3.1. System Analysis and Design	8
3.1.1. Load Balance and Sensor	8
3.1.2. Analog to Digital Conversion	10
3.1.3. The Variable Manipulation Element	12
3.1.4. The Display	15
3.1.5. The Power Supply	19

CHAPTER FOUR

4.1. Construction	20
4.1.1. Casing	20
4.2. Suggestions on hoe to improve this project	21
4.3. Problems Encountered	21

CHAPTER FIVE

5.1.1. Conclusions and Recommendations	22
--	----

References	23
-------------------	----

Appendix	24
-----------------	----

CHAPTER ONE

1.1 INTRODUCTION

From earliest times the concept of measurement has been a necessity for man. This has led to continual advances in the field of measurement and instrumentation. Measurement is an act or a result of quantitative comparison between a predefined standard and an unknown magnitude [1]. These standards include the meter, kilogram, liter e. t. c.

A scale or balance is a mechanical or electronic device used to measure the mass of an object or quantity of some substance using its weight.

Weight is the downward force resulting from the gravitational attraction of the earth. This is given as mass (m) multiplied by gravity (g).

$$F = W = mg$$

Measuring instruments are essential components of a control system. Measurement is therefore necessary for evaluating the performance of a system or studying the response of such system to a particular input function. It also applies in the study of some basic laws of nature [1]. Weight scales are a necessity for monitoring purposes in homes and fitness centers. They are also found in hospitals for weighing patients and new born babies.

The control of weight calls for constant measurement as a number of diseases such as obesity, strokes, heart attacks, coronary heart disease and other cardiovascular diseases have been discovered to be related to excessive weight [2]. On the other hand issues on malnutrition and under weight also give credence to the need of measurement scales. Since the weight of a man is an indicator to the state of his health.

It is worthy of note that the numerous advances in the medical and health fields can be attributed to electrical and electronic inputs.

1.2 THE ADVANTAGE OF DIGITAL SYSTEMS OVER ANALOGUE SYSTEMS

A digital system at its lowest level is a network of wires and mechanical parts whose voltages and positions convey coded information. These codes are numbers which are represented by circuits that distinguish various discrete electrical signals on wires inside the machine basically as 0's and 1's corresponding to the binary number system. Analogue systems on the other hand have signals that vary continuously with the input.

Digital systems unlike analogue systems are free from scaling requirements and are more convenient to operate. They possess higher sensitivity, speed, and accuracy. They respond dynamically to changes in the input and also possess freedom from operator errors and error due to parallax. Analogue signals can be converted to digital signals using Analogue to Digital converters (ADCs).

1.3. AIMS AND OBJECTIVES

Applying the advantages of digital electronics, this project is aimed at designing and constructing a weight scale whose weight measure would be given as a digital output. This project aims at a low cost implication of the design while maintaining portability. As accuracy and sensitivity is the measure of a scales quality, precision remains a primary objective of this work.

1.4. GENERAL DESCRIPTION OF A MEASURING SYSTEM

An instrument to be used to measure a quantity of a medium should generally contain the following elements as represented in the block diagram below.

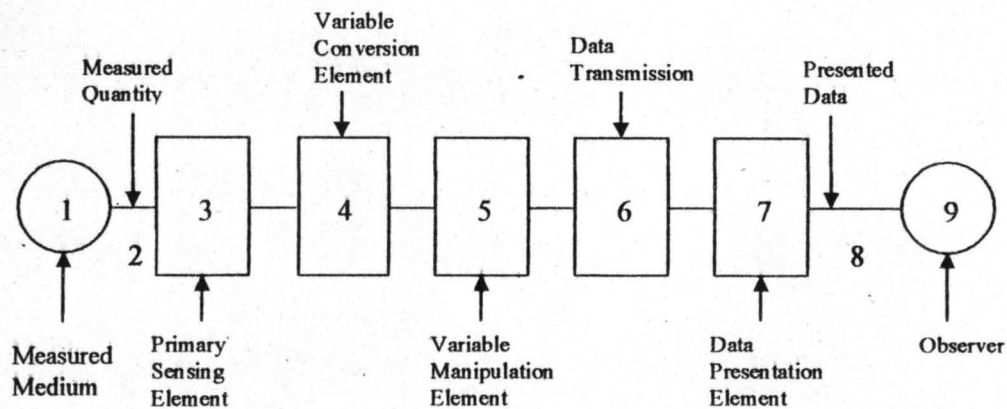

Fig 1.1: Block diagram of a generalized measuring system

After the quantity is observed, the **primary sensing element** is the first to receive the energy to be measured producing a proportional output. This output signal is a physical variable. This implies that it is a transducer. A transducer is a sensor that converts one physical variable or effect to another. The sensor should be designed to extract very small energy from the medium. The output of the primary sensing element may need to be converted to a more suitable variable signal while preserving its information. This is the job of the **variable conversion element**. The **variable manipulation element** modifies the signal by direct signal amplification, filtering e. t. c. so that the appropriate output is produced. The physical nature of the variable is however unchanged. In the case of spatial separation of measuring elements the signal is transmitted to the next element by the **data transmission element**. The quantity is then

communicated to the observer in a form recognizable to the human senses. This is the assignment of the **data presentation element**. [1]

CHAPTER TWO

2.1. LITERATURE REVIEW

The balance (derived from the Latin word "bilanx" meaning two plates) referred to as scales in these modern times, was used first by the ancient Egyptians and Babylonians at about 5000 BC [3]. It consisted of a simple beam pivoted at its center with standard weight in one pan and the unknown weight in the other. The Romans improved on this when at the pivoted point they fixed a triangle section to the beam increasing its accuracy and sensitivity. This was called the equal arm balance. It had two pans suspended from a light weight rigid beam pivoted at the center on an agate knife edge resting on an agate plate at the top of the central column of the balance. The two pans hung from stirrups supported by the agate plate. A pointer attached to the beam centre extended down to a scale at the bottom of the column to indicate when the beam was horizontal i.e. the two pans were equally loaded [4].

A further improvement brought about the single pan balance having one pan and a fixed counter weight at the other end. This further gave rise to the steelyards used by the Danish and the Romans about 2000 years ago.

However, the chemist Joseph Black (1728 – 1799) of Scottish decent was credited for the first use of a balance. Spring scales came as a further development. They operate on the principle that when a helix is subjected to tension the amount of elongation increases proportionally with the increase in the force of tension. The spring balance includes a helical spring suspended from a fixed point carrying a weighing pan. Improvements brought in the weighing pan which was patented in 1831 by Thaddeus Fair Banks of St. John bury Vt [4]

2.1.1. THE ANALOGUE BATHROOM SCALE

The analogue spring scale has taken many forms. However the same principles are involved. A lever with its fulcrum moved to the end of the lever. The weight is applied to the lever close to the fulcrum and a balancing is supplied by the extension of a spring at the opposite end. See fig 2.1

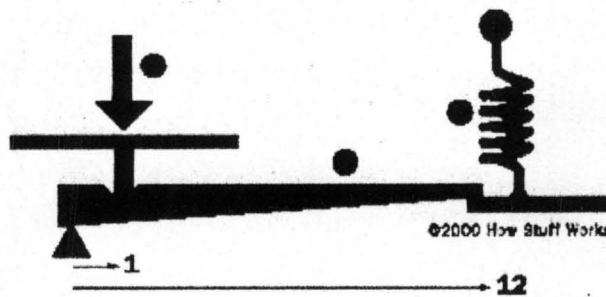

Fig 2.1. The Analog scale balance principle

This set up means the spring needs only to supply a fraction of the weight to the object to balance the lever. The ratio 1:12 means that the spring is extended until the restoring force reaches only 1/12 of the weight applied. This helps to keep the scale compact.

The actual implementation in the scale involves the use of four levers with fulcrums at the corners to distribute the load on the base of the scale. The rear levers couple to the front levers at about half way their length. The front levers are then coupled to a steel plate connected to the bottom of a spring. The cover of the scale which is the platform on which the load rests transfers the weight to the levers. It is connected to the levers using four special brackets designed to fit into depressions in the levers. They are fixed to the underside of the cover.

The vertical extension of the spring is converted to horizontal motion by a lever which rests on top of the steel plate. This lever follows the plate downwards when a weight is applied. An extended spring connected to this lever drives a metal bar having saw tooth grooves at one side. The horizontal motion of the saw tooth grooves drives the wheel of a calibrated dial. See fig 2.2

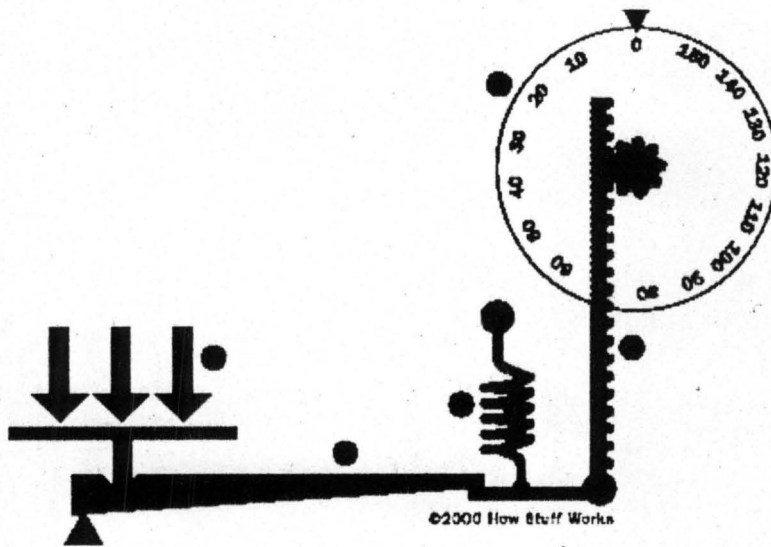

Fig 2.2. The Analog scale system

CHAPTER THREE

3.1 SYSTEM ANALYSIS AND DESIGN.

From the general block diagram of a measurement system a functional block diagram as relates to the digital weight scale is shown below.

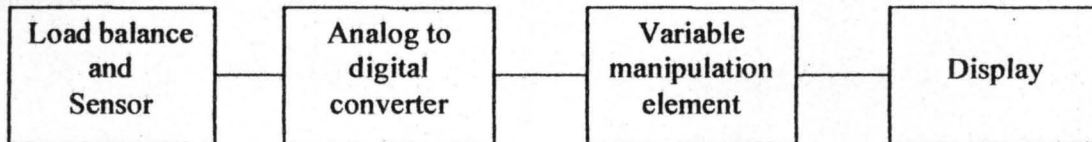

Fig 3.1: Block diagram of a digital weight scale.

3.1.1. LOAD BALANCE AND SENSOR

The load balance system used in the analogue scale is adopted because of its effectiveness and reliability. The scale further explained has a top cover having four brackets attached that fits into four levers. These brackets cause the weight on top of the scale to be distributed evenly to the levers. These levers make for appropriate weight distribution. From Fig 2.1., it is observed that the weight at the right end is significantly reduced by the difference between the lengths from the left end to the right end. This is the ratio 1:12 so that a 120kg weight on the scale is perceived as a 10kg weight on the spring. Normally a weight of 120kg corresponds to:

$$\begin{aligned} W &= M * g \\ &= 120 * 9.81 \\ &= 1177.2 \text{ N} \end{aligned}$$

A coil spring that will provide such a restoring force would require a spring constant of 117.72 KN/m. Such a spring is not feasible, considering that for the size of the scale the extension permitted is only 1cm. With the four lever arrangement however the restoring force reaches only half of the weight applied, therefore for a 120kg weight only a restoring force of $1177 / 12 = 98.1$ N would require a spring constant of 9.81 KN/m.

This is in accordance with Hooke's law:

$$F = K * e$$

Where: F = restoring force, e = Extension, k = Spring constant

The spring has a spring plate attached to it. As the spring compresses under the weight, the plate moves down and as the weight is released the spring relaxes and the plate moves up. The up down movement is passed to a pivot which controls the metal bar. The slider of a variable resistor is connected to the metal bar. The variable resistor possesses three terminals which are all connected. It is in essence a potentiometer. The potentiometer acts as a sensor converting the movement of the bar to a proportional resistance. This occurs as the forward movement of the metal bar pushes the slider of the potentiometer causing a varying of the resistance which results in a varying output voltage. The slider is set so that when there is no weight on the scale, there is no resistance produced. The more the weight, the larger the variation of the resistance and the higher the out put of the resistance and the higher the out voltage.

This is in accordance with to ohms law:

$$V \propto R$$

$$V = IR$$

Where V = voltage, R = Resistance, I = Current

3.1 .2 THE ANALOGUE TO DIGITAL CONVERSION

The analogue to digital conversion system comprises of two integrated circuits (IC's): the ADC 0804 is the analogue to digital converter while the 40103 A is responsible for the base 2 to base 10 conversion.

ADC 0804:

The ADC 0804 is an 8 bit analogue to digital converter integrated circuit. It is a CMOS successive approximation converter. Its output is binary. Its inputs and outputs are both MOS and TTL compatible. The ADC 0804 requires a +5V dc power supply to operate.

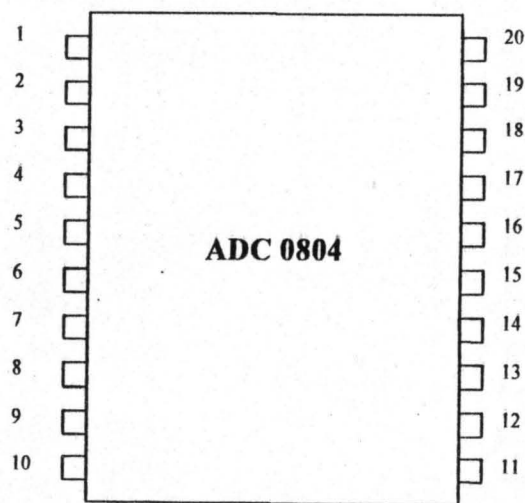

Fig 3.2: Pin diagram for ADC 0804

Table 3.1 Pin labels and functions

S/N	SYMBOL	FUNCTION	DESCRIPTION
1	CS	INPUT	Chip select line from microprocessor control
2	RD	INPUT	Read line from microprocessor control
3	WR	INPUT	Write line from microprocessor control
4	CLK IN	INPUT	Clock interrupt line
5	INTR	OUTPUT	Output
6	V _{in} +	INPUT	Analogue voltage (+ve input)
7	V _{in} -	INPUT	Analogue voltage (-ve input)
8	AGND	POWER	Analogue ground
9	V _{ref} =	INPUT	Alternate voltage reference
10	DGND	POWER	Digital ground
11	DB ₀	OUTPUT	MSB data output
12	DB ₁	OUTPUT	Data output
13	DB ₂	OUTPUT	Data output
14	DB ₃	OUTPUT	Data output
15	DB ₄	OUTPUT	Data output
16	DB ₅	OUTPUT	Data output
17	DB ₆	OUTPUT	Data output
18	DB ₇	OUTPUT	LSB data output
19	CLK R	INPUT	External resistor connection for clock
20	V _{cc}	POWER	5V power supply and primary reference voltage

A 10K Ω resistor is connected to pin19 (CLK R) and a 150 pF capacitor is connected to Pin 4 (CLK IN) inputs of the ADC 0804 integrated circuit (IC) to cause the internal clock to operate. The 10 volts resistor is used as an external pull up resistor to ensure a +5v output voltage for a HIGH. The data outputs DB₇ to DB₀ are binary outputs. They are active HIGH three state outputs. The WR can be thought of as a clock input with the interrupt output INTR pulsing the WR input at the end of each analog to digital conversion. A low to high transition of the signal at the WR pin starts the A/D converter process. At completion of a conversion the output is updated and the INTR output emits a negative pulse. This is fed back to the clock through the WR input so as to initiate another A/D conversion. The conversion rate

of the ADC 0804 is high. This is an advantage of the successive approximation A/D when compared to the ramp type [6].

3.1.3 THE VARIABLE MANIPULATION ELEMENT

This can also be termed the calibration unit. This section is responsible for adjusting the digital output to the appropriate variable to obtain correct measurement. It consists of two ICs the 40103B IC and the 4518B IC.

4518B

The 4518B is a dual 4 - bit internally synchronous BCD counter. It has a typical count frequency of 5 MHz at V_{DD} , it could be triggered on by either a low to high transmission or a high to low transition. It offers fully synchronous counting but its active high master set is asynchronous. All outputs are buffered from all four bit positions. Fig 3.4 shows the pin diagram for the 4518B IC [7].

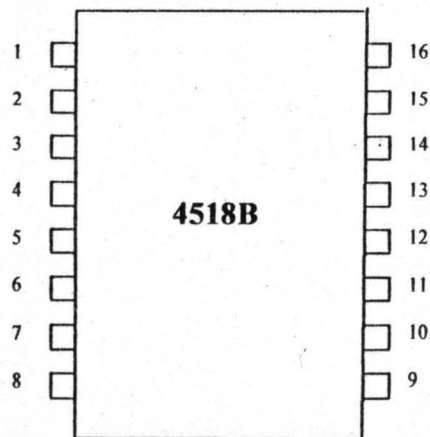

Fig 3.4 pin diagram for 4518B

Table 3.2 pin labels And functions

S/N	Symbol	Name
1	CP _{0a}	Clock input (L-H Triggered)
2	CP _{1a}	Clock input (H-L Triggered)
3	Q _{0a}	Outputs
4	Q _{1a}	Outputs
5	Q _{2a}	Outputs
6	Q _{3a}	Outputs
7	MR _a	Masters Reset Input
8	V _{SS}	Power (ground)
9	CP _{0b}	Clock input (L-H Triggered)
10	CP _{1b}	Clock input (H-L Triggered)
11	Q _{0a}	Outputs
12	Q _{1b}	Outputs
13	Q _{2b}	Outputs
14	Q _{3b}	Outputs
15	MR _b	Masters Reset Input
16	V _{DD}	Power (5volts reference)

Table 3.3. Truth table for 4518B operation.

CP ₀	CP ₁	MR	Mode
+ve transition	H	L	Counter advances
L	-ve transition	L	Counter advances
-ve transition	X	L	No change
X	+ve transition	L	No change
+ve transition	L	L	No change
H	-ve transition	L	No change
X	X	H	Reset (asynchronous)

The datasheet of the 4581B IC is given in Table 3.4 showing its DC characteristics

Table 3.4 Data sheet for 4581B IC.

Symbol	Parameter	limits $V_{DD}=5v$			Unit	Temp
IDD	Quiescent	M	T	M	μA	Min 25° C
		IN	Y	A		
		P	X	20		
	Power			150	μA	Min 25° C
Supply			5			
Current			150			

40103B

The 40103B is a monolithic integrated circuit fabricated with MOS Technology. The dual in line packaged model is used for it conveniences. 40103B consist of an 8 stage synchronous down counter, a single 8- bit binary counter and control inputs for enabling and disabling the clock. These inputs also clear the counter to its maximum count and preset the counter either synchronously or asynchronously as desired. The control inputs and the carry-out/zero detect output are active low logic operated. In normal operation the counter is decremented by one count on each +ve transition of the clock. Counting is inhibited when the carry in / counter enable input is high, its 8 JAM input pins $J_0 - J_7$ represent a single 8-bit binary word [8]. The pin arrangement is shown in fig 3.6.

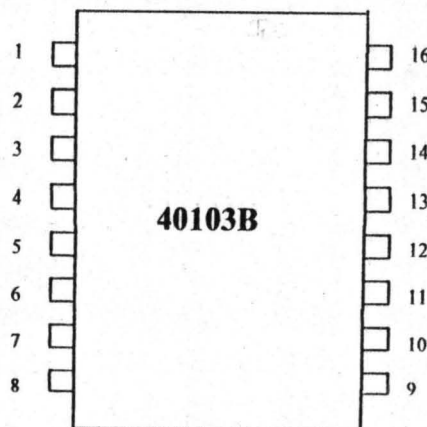

Fig 3.6 Pin diagram for 40103B

Table 3:5 Pin labels and functions

Pin N ^o	Name and Function	Symbol
1	Clock input (Low–High edge triggered)	CLK
2	Asynchronous Master reset input (active low)	CLR
3	Terminal Enable Input	CI/CE
4-7	JAM inputs	J ₀ -J ₇
8	Supply Voltage (-ve)	APE
9	Asynchronous Preset enable input(active low)	CO/ZD
10-13	JAM inputs	J ₁₀ -J ₁₃
14	Terminal count output (active low)	SPE
15	Synchronous Preset Enable input(active low)	V _{DD}
16	Supply voltage (+ve)	V _{SS}

The out puts of pin 14 (terminal count output) and that of pin 1(clock input) are compared so as to control the latch enable (pin 5) of the seven segment display driver. The clock input of the BCD counter which is high to low triggered and the Master Reset of the 4518 IC also depend on the output of the afore mention pins. The 4081IC and the 4069IC which consist of four and or gates respectively are used to configure the output response to give the required input to activate the ICs. In essence it forms a debouncing circuit to make the counter function properly

3.1.4 THE DISPLAY

The display segment consists of 3 common anode display IC and a 4511B IC. The 4511b is a BCD to seven segment latch/decoder/driver CMOS IC. Its Pin arrangement is shown fig 3.8

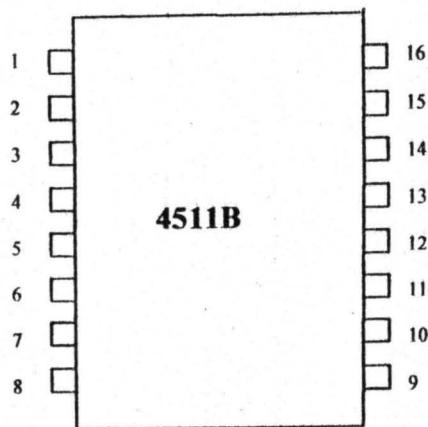

Fig 3.8 Pin diagram for 4511B

Table 3.6. Pin labels and functions

S/N	Symbol	Function	Description
1	B	Input	Data Input
2	C	Input	Data Input
3	LT	Input	Lamp Test
4	BI	Input	Blanking Input
5	LE	Input	Latch Enable
6	D	Input	Data Input
7	A	Input	Data Input
8	V _{SS}	Power	5V Input Voltage
9	e	Output	Data Output
10	d	Output	Data Output
11	c	Output	Data Output
12	b	Output	Data Output
13	a	Output	Data Output
14	g	Output	Data Output
15	f	Output	Data Output
16	V _{CC}	Power	Ground

The truth table of its operation is drawn in Table 3.7

Table 3.6 Truth Table for 4511B operations.

Display	LE	BI	LT	D C B A	a b c d e f g
B	x	x	0	x x x x	1 1 1 1 1 1 1
	x	0	1	x x x x	0 0 0 0 0 0 0
0	0	1	1	0 0 0 0	1 1 1 1 1 1 0
1	0	1	1	0 0 0 1	0 1 1 0 0 0 0
2	0	1	1	0 0 1 0	1 1 0 1 1 0 1
3	0	1	1	0 0 1 1	1 1 1 1 0 0 1
4	0	1	1	0 1 0 0	0 1 1 0 0 1 1
5	0	1	1	0 1 0 1	1 0 1 1 0 1 1
6	0	1	1	0 1 1 0	0 0 1 1 1 1 1
7	0	1	1	0 1 1 1	1 1 1 0 0 0 0
8	0	1	1	0 0 0 0	1 1 1 1 1 1 1
9	0	1	1	1 0 0 1	1 1 1 0 0 1 1
	0	1	1	1 0 1 0	0 0 0 0 0 0 0
	0	1	1	1 0 1 1	0 0 0 0 0 0 0
	0	1	1	1 1 0 0	0 0 0 0 0 0 0
	0	1	1	1 1 0 1	0 0 0 0 0 0 0
	0	1	1	1 1 1 0	0 0 0 0 0 0 0
	0	1	1	1 1 1 1	0 0 0 0 0 0 0
	1	1	1	1 x x x	0 0 0 0 0 0 0

When the Lamp test is activated by a LOW signal all outputs go high and all the segments of the display light up. When the blanking input is activated with a LOW all segments of the display are blanked. The latch enable is used like a memory to hold data on display while the input changes if LE pin is high then the last data present at the data inputs (A,B,C,D) is latched and held on the display. When the LE is LOW, data passes through the 4511B IC [6].

SEVEN SEGMENT DISPLAY

The seven segment display is a connection of Light Emitting Diodes (LEDs) either in the Common anode or common Cathode mode. This project however makes uses of the common anode connection. This is illustrated in fig 3.9

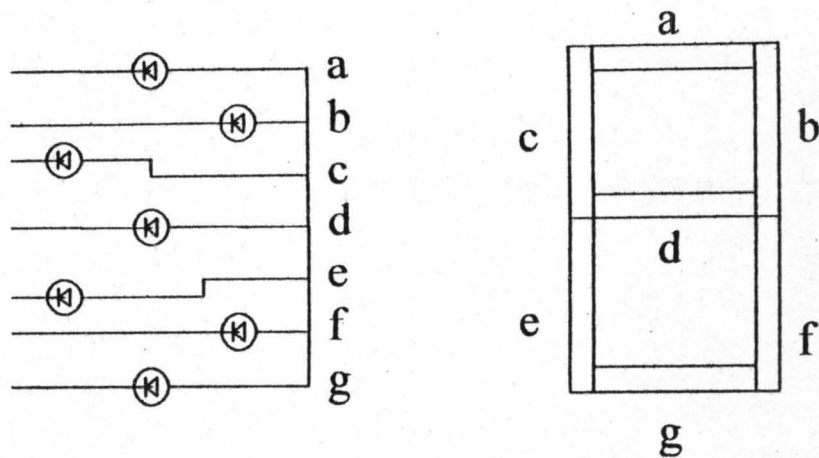

Fig 3.9 Common anode connection

A cutaway LED is basically a diode chip with a reflector. It is simply a PN junction. When the diode is forward biased, current flows through the PN junction and the LED lights up. LEDs are sensitive to polarity therefore the common anode setup would require a low logic to activate the LEDs of the seven segment display. (See fig 3.10). Seven segments displays require a driver. This informs the inclusion of the 4511B IC in the design [6].

Table 3.8 logic levels for display of digits 1-9

Display	a	b	c	d	e	f	g
1	1	1	0	1	1	1	1
2	0	0	1	0	0	1	0
3	0	0	1	0	1	0	0
4	1	0	0	0	1	0	1
5	0	1	0	0	1	0	0
6	1	1	0	0	0	0	0
7	0	0	1	1	1	0	1
8	0	0	0	0	0	0	0
9	0	0	0	0	1	0	1

The display being driven by the 4511B IC will take the form shown in fig 3.10

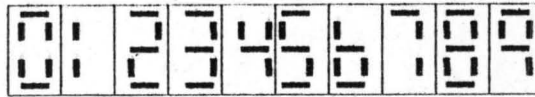

Fig 3.10 Display of digits driven 4511B

3.1.5 THE POWER SUPPLY

The power supply circuit comprises of a 9volts D.C battery connected to a switch to cut of power when the scale is not in use, and a LM 7805 IC which is a 5 volts voltage regulator, connected to a 47 μ F, 16 volts capacitor which is connected between V out and ground serving as a filter to reduce the noise output and give a steady 5volts output. The LM 7805 is drawn below.



Fig 3.7 Diagram of a LM 7805 IC

CHAPTER FOUR

4.1 CONSTRUCTION

The construction was done in two major stages. The first stage involved. The load balance system being firmly attached to the variable resistor which had been soldered unto a Vero board. The variable resistor was supported firmly on every side to ensure that the was no movement when weight pressure is exerted on it and also to ensure that the slider moves smoothly in a straight line the supports ensured that the potentiometer was erect and not sloping at all sides. A 9 volt DC battery was connected and different weights were used to test for voltage output.

In the second stage, the ICs were soldered first unto the Vero Board. Each of the pins was then connected to the appropriate components according to the requirements of the schematics of the design using thin copper wires or negligible resistance. Two 4518ICs were used for convenience. All pins not in use were carefully grounded.

4.1.1 CASING

The casing of the normal analog weight scale was employed as it is the most appropriate for the load balancing and it provides a platform on which the weights are placed. Its small and compact nature is an added advantage of the casing used. The switch is located within reach of the user. The battery can easily be replaced when required.

4.2 SUGGESTIONS ON HOW TO IMPROVE THIS PROJECT

Research has gone into the use of strain gauges attached to a metal beam as an alternative sensor however, they are expensive and hard to get but they are already being used to implement digital weight scales. Another alternative sensor piezoelectric but this is also a rear and expensive as load cell options. They could help to improve the sensitivity of the scale. An A.C power source could also be used at the expense of mobility but that will eliminate the need to change batteries frequently.

4.3 PROBLEMS ENCOUNTERED

A few difficulties accompanied the implementation of this project. They include:

1. Availability of needed components within Minna. Some could be found in other cities and a few had to be replaced with the most suitable alternatives. This added to project cost and design time.
2. Needed information was difficult to find
3. Skill had to be acquired on the job. This was advantageous on one hand but it hampered the speed of the work.

CHAPTER FIVE

5.1 CONCLUSION AND RECCOMENDATIONS

The digital weight scale was constructed and the results were as obtained with minimally deviated from expectation. It was achieved cost effectively and it maintained the portability known with the analog bathroom scale, all the more because it is battery powered although the batteries would have to be change occasionally. The switch included adds to the scale power saving advantage as it can be switched off when not in use.

The digital weight scale functions well for the measurement of human weight and it could fast replace the analogue scale in homes and hospitals. It shows the relevance of electronics to every facet of human life.

From my experience with this work I recommend that project supervisors be given to students before they proceed for their Industrial attachment. This will greatly facilitate an early start of the work.

REFERENCES

- [1] R.S Sirchi and H.C Radha Krishna, "Mechanical Measurements" 3rd Edition.
Wiley Eastern Limited, New Dehli pp 1-5
- [2] N. Potter and J.H. Hutchins, "Food Science", 5th Edition. *CDs publishers*
- [3] *Encarta Encyclopedia 2004*
- [4] *The Encyclopedia Americana International Edition. Grolier Incorporated*
- [5] www.howstuffworks.com
- [6] Roger. L. Tokeim, "Digital Electronics. Principles and application", 5th Edition, *Glencoe Mc-Graw Hill, New York, 1999, pp 377-378, pp 145, pp 129*
- [7] Data sheet for 4518B
- [8] Data sheet for 40103B

APPENDIX A

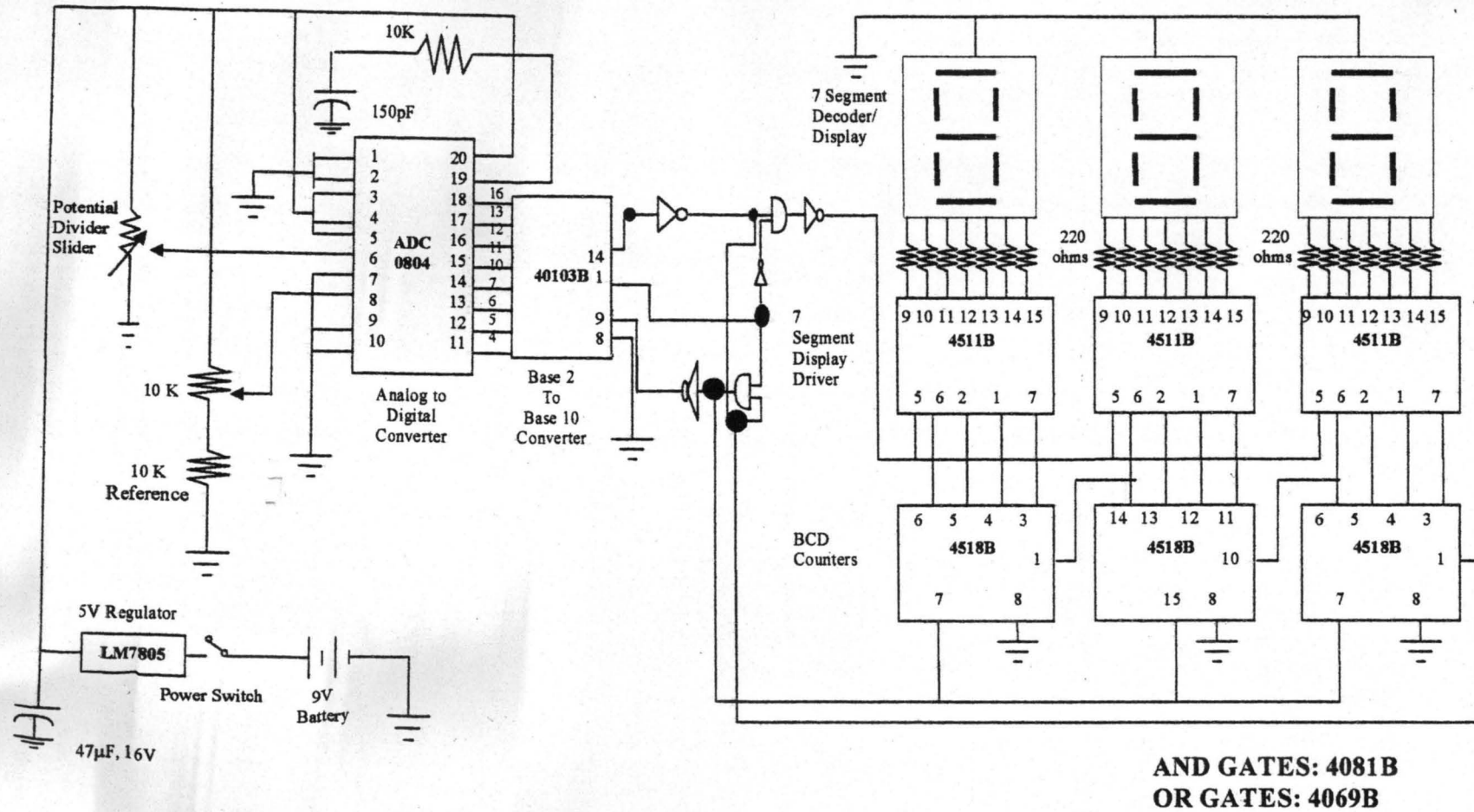

CIRCUIT OF A DIGITAL WEIGHT SCALE

APPENDIX B

BILL OF QUANTITIES

ITEM	N°	PRICE (N)	TOTAL (N)
Vero board		100	100
ADC0804	1	1200	1200
40103B	1	150	150
4511B	3	120	360
4518B	2	140	280
Casing		700	700
Variable Resistor	1	150	150
220ohms Resistor	21	20	420
10k Resistors	3	150	150
LM7805	1	100	100
Switch	1	80	80
4081B	2	100	200
4069B	4	100	400
7 Segment display	3	150	450
150pF Capacitor	1	80	80
9V Battery	1	80	80
47 μ F Capacitor	1	100	100
Copper wires	1 row	120	120
TOTAL			5690