

# DESIGN AND CONSTRUCTION OF REMOTE CONTROLLED SOCKET OUTLET

OBI OKWUCHUKWU  
2005/22064EE

A PROJECT SUBMITTED TO THE DEPARTMENT  
OF ELECTRICAL AND COMPUTER  
ENGINEERING,  
FEDERAL UNIVERSITY OF TECHNOLOGY  
MINNA, NIGER STATE.

**NOVEMBER 2010**

## **Dedication**

I dedicate this project to God Almighty, who has brought me this far, and also to my dad and mum, Mr & Mrs Obi Okoye.

## Declaration

I, Okwuchukwu Obi, declare that this work was done by me and has never been presented elsewhere for the award of a degree. I also hereby relinquish the copyright to the Federal University of Technology, Minna.

Okwuchukwu Obi

Mr Adejo Achonu

.....  
(Name of student)

.....  
(Name of Supervisor)

 01/11/10

.....  
(Signature and date)

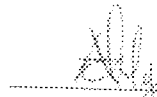
 01/11/2010

.....  
(Signature and date)

Engr A G. Raji

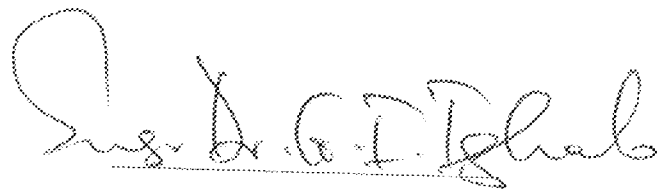

.....  
(Name of Head of Department)

.....  
(Name of External Examiner)

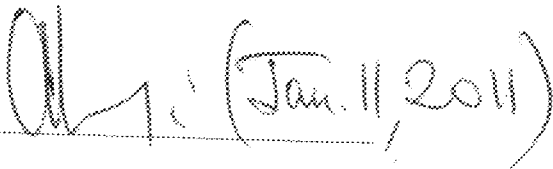
 (Jan. 11, 2011)

.....  
(Signature and date)

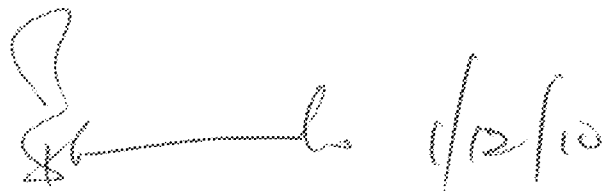
 1/12/10

.....  
(Signature and date)

## **Acknowledgement**

I wish to express my gratitude to Almighty God for making this work a success. I also wish to appreciate those who assisted me in one way or the other. My special thanks go to my Supervisor Mr Adejo Achonu, Engr J. Abolarinwa(former); they were great inspiration to me, and Mallam Baguda who was always there for me when I needed him.

My appreciation goes to my immediate family members: my Mum, Lucy Obi Okoye, my dad, Goerge Obi Okoye and to also my one and only sister Uchenna Obi Okoye for her encouragement and great support in all aspects during this project work.

## **Abstract**

The design and construction of an infrared remote controlled switch consists of developing a small hand held remote control with a push button, which, when pressed down gives out an infrared light that triggers the constructed socket outlet, which has an infrared sensor attached to it that senses the infrared light emitted by the transmitting remote control. The sensed infrared light changes the state of the socket outlet at every push made on the remote control. The constructed remote controlled switch has an effective range of 10 meters.

# Table of contents

Dedication.....	i
Declaration.....	ii
Acknowledgement.....	iii
Abstract.....	iv
Table of content.....	v
List of figures.....	vii
List of table.....	ix
<b>Chapter One</b> .....	<b>1</b>
1 General Introduction.....	1
2 Objectives and motivation.....	3
3 Methodology.....	3
4 Scope of project.....	4
5 Project outline.....	5
<b>Chapter Two: literature review</b> .....	<b>6</b>
10 General history of remote control.....	6
11 History of TV remote control.....	7
12 History of other remote control.....	9
13 Proliferation of remote control.....	9
20 Theoretical background.....	10
30 Previous related works of others on remote controlled socket outlet.....	13

<b>Chapter Three: design and implementation.....</b>	<b>15</b>
3.1 Design.....	15
3.2 Infrared transmitter.....	16
3.3 Infrared receiver socket outlet.....	23
<b>Chapter four: Test and discussion of result .....</b>	<b>38</b>
4.1 Construction procedure and precaution.....	38
4.2 Testing and measurement.....	38
4.3 Photographic plate of project and casing.....	39
4.4 Result.....	40
4.5 Limitation and possible remedy.....	40
4.6 Problem encountered.....	41
<b>Chapter five: Conclusion and recommendation .....</b>	<b>42</b>
5.1 Conclusion.....	42
5.2 Recommendation.....	42
References.....	43

## List of Figures

Fig.1: wave form of an electromagnetic spectrum.....	11
Fig 2: The emission spectrum of a typical sound system remote control is in the near infrared.....	12
Fig 3.1: A Block diagram of the IR Transmitter Circuit.....	15
Fig 3.2: A Block Diagram Of The Receiver Circuit .....	15
Fig 3.3 A complete block diagram of remote controlled infrared socket outlet.....	16
Fig 3.4 The figure above shows the top view of a 555timer and its pins.....	17
Fig 3.5: Shows the block diagram of a 555timer.....	17
Fig 3.6 Circuit Diagram of the Infrared Transmitter.....	19
Fig 3.7: Operation of the 555 timer in the astable mode.....	19
Fig 3.8 Diagram of Infrared LED Protected by a Limiting Resistor.....	23
Fig. 3.9: Block Diagram of the Power Supply Unit.....	24
Fig.3.10: Voltage Regulator.....	28
Figure 3.11 logical operation of a 2- input nand gate.....	29
Fig 3.12: internal circuitry of a 4093 IC.....	30
Fig 3.13: Symbol of D-Flip Flop.....	31



Fig. 3.14: Input and Output Waveforms of Clocked D-Flip Flop.....	32
Fig. 3.15: Toggle Mode Connection of D-Flip Flop.....	33
Fig. 3.16: Input and Output Waveforms of Toggle Flip Flop.....	33
Fig.3.17: Schematic Diagram of MOC3020 Opto Coupler. ....	34
Fig. 3.18: The AC10DT Triac.....	35
Fig. 3.19: Triac Symbol.....	36
Fig 20: Circuit diagram of the receiver circuit.....	37
Fig 4.1 photograph of the transmitting circuit.....	39
Fig 4.2 photograph of receiver wiring connection.....	39

## List of Tables

Table 1: Truth table of two input nand gate.....	30
Table 2: Truth Table of D-Flip Flop.....	32

# CHAPTER ONE

## INTRODUCTION

### 1.1 GENERAL INTRODUCTION.

A remote control is a component of an electronic device, (commonly a television set, sound systems, video player, multimedia system e.t.c) used for operating the device wirelessly from a short line of sight distance. The remote control can be contracted to remote or control. It is known by many other names such as didge, flipper, the tuner or the changer. Commonly, remote controls are consumer infrared devices used to issue command from a distance to other consumer electronics.[1] For the remote controlled socket outlet, it is a small handheld device with a SET and RESET button for triggering the socket outlet to its ON and OFF states as required.

In Nigeria today, the use of manual switch is the most widely known switching device for most socket outlets. This manual switch is being designed in a way which the rocker switch connects and breaks the live connection to the main outlet or still, a switch is used to make or interrupt a circuit. A complete switch consists of three parts which is the mechanism itself, a box containing it and a front plate over it. The older type of switch mechanism was dolly operated in which its moving contact would be on a spring lever which is then moved by the cam. The dolly switch in recent times is no longer in use, the switches, which are widely used today are the rocker operated switch. This switch type has a rocker which is pivoted at its centre and carries a spring loaded ball. The ball presses on the moving contact and the combination acts as a toggle; the spring always

forces the moving contact into one of the extreme positions. The switch opens when the bottom of the rocker is pressed and closes when the top is pressed.

**The advantage a rocker switch has is that:**

1. It can be easily operated
2. The impossibility of opening half way.

But this switch also has its own disadvantages which are;

1. At far distance the position of the switch cannot be easily seen at a glance whether it is open or closed.
2. Also the switch can be accidentally switched on and off.

Another type of switch is the key operated switch, in which the key has to be inserted into the switch. This type of switch is used in areas where only an authorised person can turn on and turn off the switch. Also there is the double pole switch, it operates in a way different from other switches whereby it disconnects both the live and neutral line. They are mostly with socket outlet such as Heater, Air conditioners. And are manufactured in the ratings of 15A, 20A, 30A, 45A and 60A.[2].

This socket outlet is a female socket connected to the power wiring in the building and would accept the male plug attached at the end of the flexible wire of an appliance such as electronics used at home, etc.

For loads used in domestic and commercial outlets, majority of the sockets are designed for 13A maximum loads, but for this project a 10 A socket outlet would be the focus. 10A plug can be used with the socket outlet. This socket outlet would carry any load below 10A.

In our present day, the use of the remote control is extensive, because of the high demand for comfort. We have the remote controlled television, video machines, lighting switches, air conditioners etc. With the use of a remote control these devices can be easily manipulated to perform its function.

In this project the switching of the socket out let would be done particularly via a remote controlled switch, which eliminates the need for one to walk towards a socket out let to get it switched on. With these the remote controlled switch determines when there would be a flow of current through an outlet.

## **1.2 OBJECTIVES AND MOTIVATION.**

1. Designing and constructing an Infrared remote controlled switch socket outlet.
2. The ability to switch ON and switch OFF the designed socket outlet using the designed Infrared remote control.
3. Increase comfort by eliminating the need to go and turn ON or OFF a socket outlet manually by walking in the room and to aid the physically challenged with a means of them conveniently controlling a switch.

## **1.3 METHODOLOGY.**

The design of this project comprises of two basic sections which are

1. The design of the infrared remote transmitter and
2. The design of the infrared remote receiver unit.

The first section which is the design of the infrared transmitter sets the frequency of the signal to be transmitted and does the transmission. It comprises of an NE555 timer as its

major component and resistors and a capacitor whose combination sets the frequency of the transmitted signal. The signal will be transmitted by an Infrared Light Emitting Diode (Infrared LED) while the whole circuit will be powered by a 9V battery.

The second section which is the Infrared remote receiver unit comprises of an Infrared receiver module, a quad two input NAND schmitt trigger, a Dual D Flip-Flop with Set and Reset, an opto coupler, and a Triac as switch. The whole unit is powered by a 5V constant dc voltage supply.

This project is designed to be used with appliances that are between 10A and below. Based on the design, only one condition is obtainable at a time i.e. the socket outlet is either ON or OFF.

A major improvement of this project over earlier ones is the use of a Triac in place of the relay. This is chosen because of its low power consumption and fast and efficient switching capabilities over the relay.

The project design was enhance with the aid of relevant information and materials from the internet, relevant textbooks, encyclopaedias and basic knowledge as well as related past projects.

#### **1.4 THE SCOPE OF THE PROJECT**

The project covers the design and construction of an Infrared remote controlled socket outlet. This includes the design and construction of an Infrared remote transmitter and its corresponding receiver unit which will perform the control of the switching system. The receiver unit is to control the socket outlet system logically by responding to pulses received by the infrared receiver from the Infrared remote transmitter.

## **1.5 PROJECT OUTLINE**

Chapter one covers the introduction, aim and objectives, methodology, scope of project and project outline.

Chapter two is the literature review and covers the history of remote control and previous related works on infrared remote controlled socket outlet.

Chapter three covers the design and construction of the infrared remote controlled socket outlet with their block diagrams and circuit diagrams and calculation made during construction.

Chapter four covers the test and discussion of result and also the picture of the already finished work.

Chapter five covers the conclusion of the project and necessary recommendation on project.

## CHAPTER TWO

### LITERATURE REVIEW

#### 2.10 GENERAL HISTORY OF REMOTE CONTROL

The first machines to be operated by remote control were used mainly for military purposes. Radio-controlled motorboats, developed by the German navy, were used to ram enemy ships in WWI. Radio controlled bombs and other remote control weapons were used in WWII.

Once the wars were over, United States scientists experimented to find non-military uses for the remote control. In the late 1940's automatic garage door openers were invented, and in the 1950's the first TV remote controls were used. [3]

One of the earliest examples of remote control was developed in 1898 by Nikola Tesla, and described in his patent, U.S. Patent 613,809, named Method of an Apparatus for Controlling Mechanism of Moving Vehicle or Vehicles. In 1898, he demonstrated a radio-controlled boat to the public during an electrical exhibition at Madison Square Garden. Tesla called his boat a "teleautomaton" [4]

In 1903, Leonardo Torres Quevedo presented the Telekino at the Paris Academy of Science, accompanied by a brief, and making an experimental demonstration. In the same time he obtained a patent in France, Spain, Great Britain, and the United States. The Telekino consisted of a robot that executed commands transmitted by electromagnetic waves. It constituted the world's first apparatus for radio control and was a pioneer in the



field of remote control. In 1906, in the presence of the king and before a great crowd, Torres successfully demonstrated the invention in the port of Bilbao, guiding a boat from the shore. Later, he would try to apply the Telekino to projectiles and torpedoes, but had to abandon the project for lack of financing. The first remote-controlled model aeroplane flew in 1932, and the use of remote control technology for military purposes was worked intensively during the Second World War, one result of this being the German Wasserfall missile. By the late 1930s, several radio manufacturers offered remote controls for some of their higher-end models. Most of these were connected to the set being controlled by wires, but the Phileo Mystery Control (1939) was a battery-operated low-frequency radio transmitter, [5] thus making it the first wireless remote control for a consumer electronics device.

## 2.11 HISTORY OF TV REMOTE CONTROL

The first remote intended to control a television was developed by Zenith Radio Corporation in 1950. The remote — officially called "Lazy Bones" — was connected to the television set by a wire. To improve the cumbersome setup, a wireless remote control called "Flashmatic" was developed in 1955 which worked by shining a beam of light onto a photoelectric cell. Unfortunately, the cells did not distinguish between light from the remote and light from other sources and the Flashmatic also required that the remote control be pointed very accurately at the receiver.[6].

In 1956 Robert Adler developed "Zenith Space Command", a wireless remote. Farhi, Paul. [7]. It was mechanical and used ultrasound to change the channel and volume. When the user pushed a button on the remote control it clicked and struck a bar, hence the term "clicker". Each bar emitted a different frequency and circuits in the television

detected this noise. The invention of the transistor made possible cheaper electronic remotes that contained a piezoelectric crystal that was fed by an oscillating electric current at a frequency near or above the upper threshold of human hearing, though still audible to dogs. The receiver contained a microphone attached to a circuit that was tuned to the same frequency. Some problems with this method were that the receiver could be triggered accidentally by naturally occurring noises, and some people, especially young women, could hear the piercing ultrasonic signals. There was even a noted incident in which a toy xylophone changed the channels on these types of TVs since some of the overtones from the xylophone matched the remote's ultrasonic frequency. The impetus for a more complex type of television remote control came in the late 1970s with the development of the Ceefax teletext service by the BBC. Most commercial remote controls at that time had a limited number of functions, sometimes as few as three: next channel, previous channel, and volume/off. This type of control did not meet the needs of teletext sets where pages were identified with three-digit numbers. A remote control to select teletext pages would need buttons for each number from zero to nine, as well as other control functions, such as switching from text to picture, and the normal television controls of volume, station, brightness, colour intensity and so on. Early teletext sets used wired remote controls to select pages but the continuous use of the remote control required for teletext quickly indicated the need for a wireless device. So BBC engineers began talks with one or two television manufacturers which led to early prototypes in around 1977-78 that could control a much larger number of functions. IFT was one of the companies and later gave its name to the IFT protocol of infrared communication. [8].

## 2.12 HISTORY OF OTHER REMOTE CONTROL

In the 1980s Steve Wozniak of Apple, started a company named CL 9. The purpose of this company was to create a remote control that could operate multiple electronic devices. The CORE unit (Controller Of Remote Equipment) was introduced in the fall of 1987. The advantage of this remote controller was that it could "learn" remote signals from different devices. It had the ability to perform specific or multiple functions at various times with its built-in clock. It was the first remote control that could be linked to a computer and loaded with updated software code as needed.

The CORE unit never made a huge impact on the market. It was much too cumbersome for the average user to program, but it received rave reviews from those who could. These obstacles eventually led to the demise of CL 9, but one of its employees continued the business under the name Celadon. This was one of the first computer-controlled learning remote controls on the market. [9]

## 2.13 The proliferation of remote controls

By the early 2000s, the number of consumer electronic devices in most homes greatly increased, along with the number of remotes to control those devices. According to the Consumer Electronics Association, an average American home has four remotes. To operate a home theater as many as five or six remotes may be required, including one for cable or satellite receiver, VCR or digital video recorder, DVD player, TV and audio amplifier. Several of these remotes may need to be used sequentially but, as there are no accepted interface guidelines, the process is increasingly cumbersome. Many specialists, including Jakob Nielsen, [10] a renowned usability specialist and Robert Adler, the

inventor of the modern remote, note how confusing, unwieldy and frustrating the multiplying remotes have become. Because of this proliferation of remote controls, universal remote controls that manage multiple devices are becoming increasingly popular.

## 2.2 THEORETICAL BACKGROUND.

Electromagnetic waves are waves which are capable of traveling through a vacuum. Unlike mechanical waves which require a medium in order to transport their energy, electromagnetic waves are capable of transporting energy through the vacuum of outer space. Electromagnetic waves are produced by a vibrating electric charge and as such, they consist of both an electric and a magnetic component.

Electromagnetic waves exist with an enormous range of frequencies. This continuous range of frequencies is known as the electromagnetic spectrum. The entire range of the spectrum is often broken into specific regions. The subdividing of the entire spectrum into smaller spectra is done mostly on the basis of how each region of electromagnetic waves interacts with matter. The diagram below depicts the electromagnetic spectrum and its various regions. The longer wavelength, lower frequency regions are located on the far left of the spectrum and the shorter wavelength, higher frequency regions are on the far right. Two very narrow regions within the spectrum are the visible light region and the X-ray region. [11]

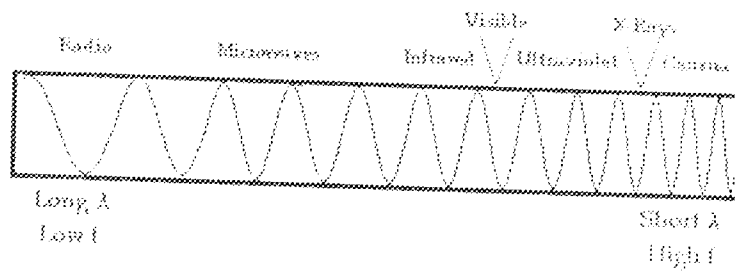

Fig 1: wave form of an electromagnetic spectrum.

The infrared range is usually divided into three regions: near infrared (nearest the visible spectrum), with wavelengths 0.78 to about 2.5 micrometres (a micrometre, or micron, is  $10^{-6}$  metre); middle infrared, with wavelengths 2.5 to about 50 micrometres; and far infrared, with wavelengths 50 to 1,000 micrometres. Most of the radiation emitted by a moderately heated surface is infrared; it forms a continuous spectrum. Molecular excitation also produces copious infrared radiation but in a discrete spectrum of lines or bands. [11]

Since infrared (IR) remote controls use light, they require line of sight to operate the destination device. The signal can, however, be reflected by mirrors, just like any other light source.

Most of these have an IR receiver, picking up the IR signal and relaying it via radio waves to the remote part, which has an IR transmitter mimicking the original IR control.

Infrared receivers also tend to have a more or less limited operating angle, which mainly depends on the optical characteristics of the phototransistor. However, it's easy to increase the operating angle using a matte transparent object in front of the receiver.

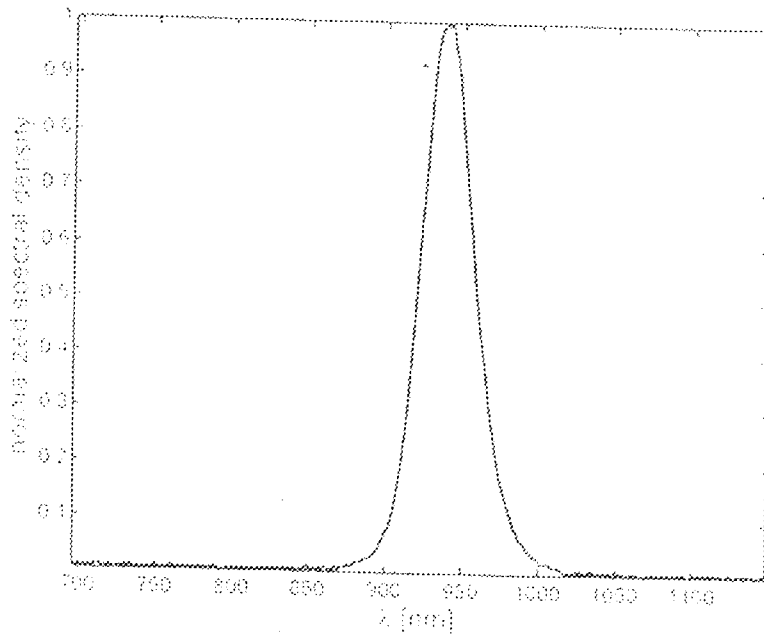

Fig.2: The emission spectrum of a typical sound system remote control is in the near infrared

Most remote controls for electronic appliances use a near infrared diode to emit a beam of light that reaches the device. A 940 nm wavelength LED is typical. This infrared light is invisible to the human eye, but picked up by sensors on the receiving device. Video cameras see the diode as if it produces visible purple light.

With a single channel (single-function, one-button) remote control the presence of a carrier signal can be used to trigger a function. For multi-channel (normal multi-function) remote controls more sophisticated procedures are necessary: one consists of modulating the carrier with signals of different frequency. After the demodulation of the received signal, the appropriate frequency filters are applied to separate the respective signals. Nowadays digital procedures are more commonly used. One can often hear the signals being modulated on the infrared carrier by operating a remote control in very close proximity to an AM radio not tuned to a station.

### 2.3 PREVIOUS RELATED WORKS OF OTHERS ON THE DESIGN OF INFRARED REMOTE CONTROLLED SWITCH

From research on a previous work, infrared signals were generated using a 555 timer at an astable mode, and then transmitted through an infrared light emitting diode at a given frequency, to the receiver circuit which performs the toggling through the use of NAND Gate, D- flip flop and a relay as the switch. The NAND GATE toggles the active low signal to a high state, is then transferred to D- FLIP FLOP which then toggles between the high and the low state any time a pulse is being received. The output of the D-FLIP FLOP is then connected to a relay, which acts as a switch to trigger a socket outlet.

Modifications made on this project in my work are:

1. The use of an upto coupler, which its internal circuitry is made up of a light emitting diode which reflects light on a light dependent transistor. This transistor triggers the TRIAC in use in my work.
2. Another major improvement of this project over earlier one is the use of a Triac in place of the relay. This is chosen because of its low power consumption and fast and efficient switching capabilities over the relay.

From another research on previous works the design of the infrared transmitter was made using the 555 timer in the astable mode, but in the circuitry the switch button was connected alongside a transistor where the transistor was acting as a switch.

In the receiver circuit a 555 timer was used in a monostable mode, when receiving the transmitted signal on the infrared sensor. Modification made in my work on this project was:

1. In place of the transistor which was used as a switch in the transmitting circuit, a simple set and reset switch was used connected across the battery.
2. In place of the 555 timer used in the monostable mode in the receiver circuit, its function was also carried out with the use of NAND gate integrated circuit.



## CHAPTER 3

### Design And Implementation

The infrared controlled socket outlet is designed around two major circuitry which are

- The IR Transmitter circuit
- The IR Receiver circuit

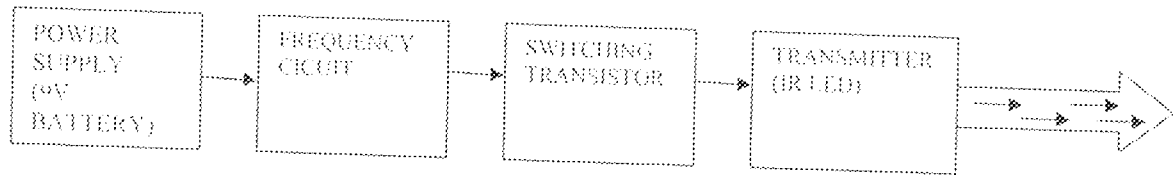

Fig 3.1: A Block diagram of the IR Transmitter Circuit

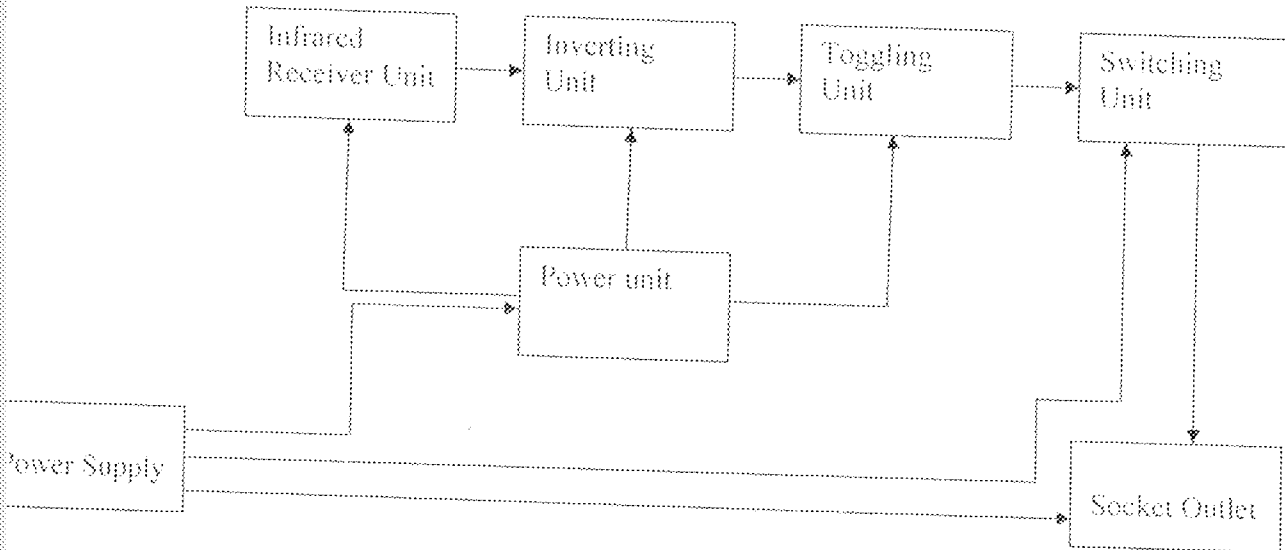

Fig 3.2: A Block Diagram Of The Receiver Circuit

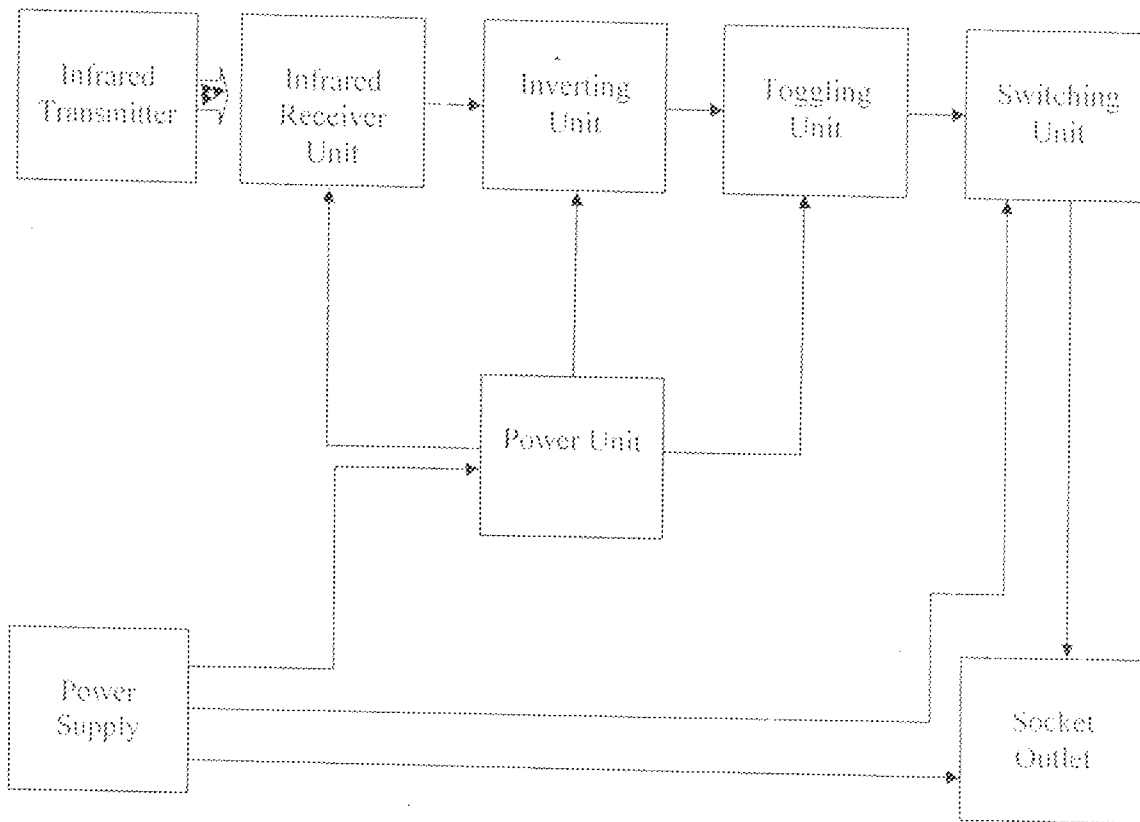

Fig 3.3: A complete block diagram of remote controlled infrared socket outlet

### 3.1 Infrared Transmitter

The design is a 40KHz oscillator designed to meet the operating requirements of the three terminal sensor used in the construction work. It produces a discontinuous burst 40KHz frequency that is sensed at the receiver to toggle the control circuitry ON/OFF.

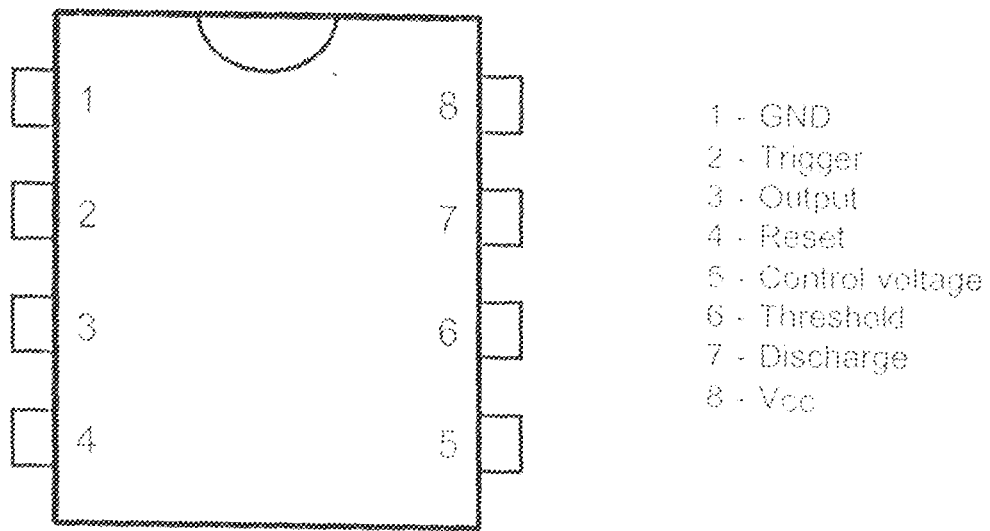

Fig 3.4: The figure above shows the top view of a 555 timer and its pins

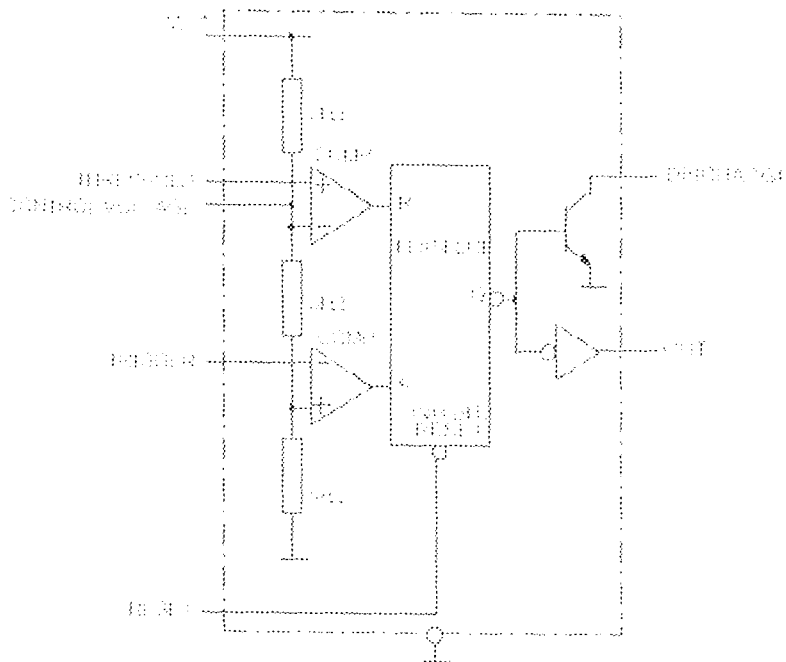

Fig 3.5: Shows the block diagram of a 555 timer.

The transmitter usually is powered by a battery. It should consume as little power as possible and the IR signal should also be as strong as possible to achieve an acceptable control distance.

For this project, a 9 volt battery was used to generate signal and the 555 timer was configured in the astable mode. The threshold input pin 6 is connected to the trigger input pin 2. The external components R1, R2 and C1 form the timing network that sets the frequency of oscillation.

When the switch is closed, power is turned on, and the capacitor "C1" uncharged, thus the trigger voltage pin 2 is a 0 volt. This causes the output of the comparator "B" to be high and output of comparator "A" to be LOW, forcing the output of the latch, and thus the base of Q1 low and keeping the transistor off. Now, C1 begins charging through R1 and R2 as shown in figure 3.2 when the capacitor voltage reaches  $1/3 V_{cc}$ , comparator B switches to its LOW output state, and when the capacitor voltage reaches  $2/3 V_{cc}$ , comparator A switches to its HIGH output state. This RESETS the latch, causing the base of Q1 to HIGH, and turns on the transistor. The capacitor now begins to discharge, causing comparator A to go LOW. At the point where the capacitor discharges down to  $1/3 V_{cc}$ , comparator B switches HIGH, this sets the latch, which makes the base Q1 LOW and turns off the transistor. Another charging cycle begins and the entire process repeats. The result is a rectangular wave output whose duty cycle depends on the values of R1 and R2.

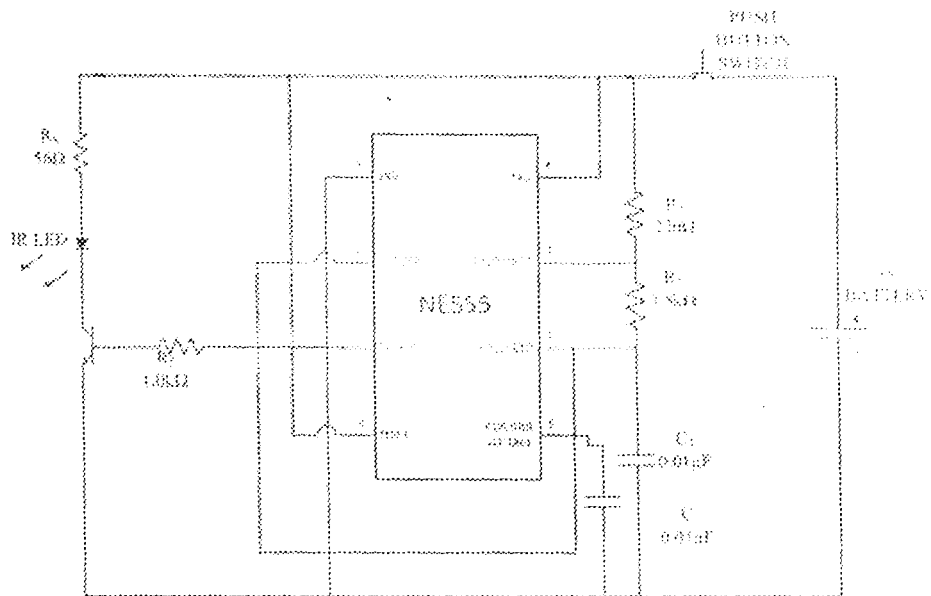

Fig 3.6 Circuit Diagram of the Infrared Transmitter

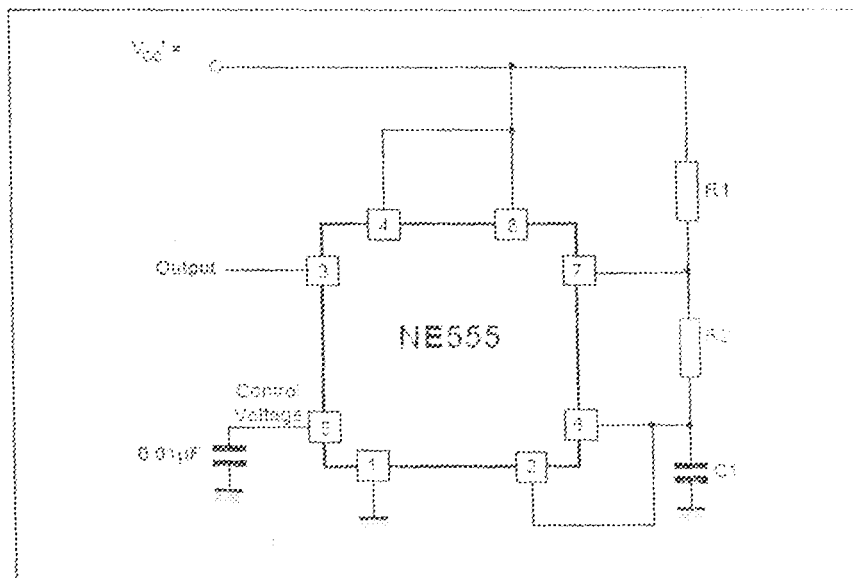

Figure 3.7: Operation of the 555 timer in the astable mode.

The resistor R2 was chosen to be 470Ω and the resistor R1 was also chosen to be 2.7KΩ for this project design in order to achieve the desired frequency range.

The capacitor alternately charges towards  $V_o$  and discharges towards zero according to the input voltage. Here the frequency of the input square wave voltage is exactly such that the capacitor is allowed to fully charge and discharge. The time constant " $T$ " is equivalent to  $KRC$ .

$$t = KRC \dots\dots\dots 1$$

### FREQUENCY CIRCUIT CALCULATION

Considering equation (1) above, the time constant  $t = KRC$  and from the figure above, it can be deduced that one period of oscillation of the RC circuit the capacitor charges for  $T_{charge}$  seconds and discharge for  $T_{discharge}$  seconds. Where  $R$  is a resistor,  $C$  is a capacitor, and  $K$  is a constant (0.693).

From the transmitter circuit in fig3.2 we have

$$R1 = 2.7K$$

$$R2 = 470$$

$$C1 = 0.01\mu f$$

$$T_{charge} = 0.693 R_t C$$

Where  $R_t$  is the sum of  $R1 + R2$

$$R_t = R1 + R2$$

$$\text{Therefore } T_{charge} = 0.693(R1+R2)C$$

$$\begin{aligned} T_{charge} &= 0.693(2.7K\Omega + 470\Omega)0.01 \times 10^{-6} \\ &= 2196.81 \times (0.01 \times 10^{-6}) \end{aligned}$$

$$T_{charge} = 21\mu s$$

$$T_{discharge} = 0.693R2C$$

$$T_{discharge} = 0.693 \times 470(0.01 \times 10^{-6})$$

$$T_{\text{discharge}} = 3.2 \mu\text{s}$$

Therefore total period of oscillation .

$$T = T_{\text{charge}} + T_{\text{discharge}}$$

$$T = 21 + 3.2$$

$$T = 24.2 \mu\text{s}$$

Frequency of oscillation is given by F

and

$$f = 1.44 / (R1 + 2R2)C \quad [12]$$

$$f = \frac{1.44}{2.7 \text{ k}\Omega + 2(470)0.01 \mu\text{f}}$$

$$f = \frac{1.44}{3640 \times 0.01 \mu\text{f}}$$

$$f = 39560.43$$

$$f \approx 40 \text{ K}\Omega$$

Time interval depends on the ON and OFF portions of the output depends upon the values of R1 and R2.

The rate of the time duration when the output pulse is high to the total period is known as the duty cycle which is denoted as D and can be calculated with this formulars.

$$D = \frac{R1 + R2}{R1 + 2R2}$$

Where

$$R1 = 2.7 \text{ K}\Omega$$

$$R2 = 470 \Omega$$

$$D = \frac{2700 + 470}{2700 + 2 \times 470}$$

$$D = 0.8709 \times 100$$

$$D = 87\%$$

OR

$$D = \frac{T_{\text{charge}}}{\text{Pulseperiodtime}} \times 100$$

Where

$$T_{\text{charge}} = 21 \mu\text{s}$$

$$\text{Pulse period time} = 24.2 \mu\text{s}$$

$$D = \frac{21 \mu\text{s}}{24.2 \mu\text{s}} \times 100$$

$$D = 87\%$$

With these duty cycle is 87%



## CALCULATIONS OF THE RESISTANCE FOR LED

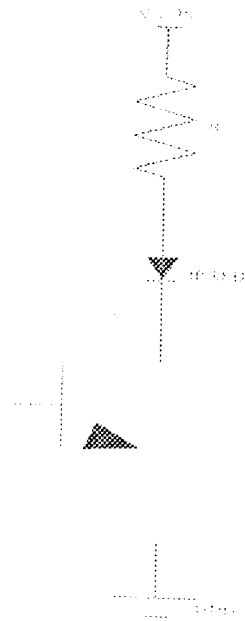

Fig 3.8 Diagram of Infrared LED Protected by a Limiting Resistor

Voltage across the circuit=sum of voltages across each component of the circuit

$$V_s = V_R + V_{LED} \dots \dots \dots (1)$$

$$= I_{LED} R_s + V_{LED}$$

But

$$V_s = 9V$$

and

$$I_{LED} \text{ Maximum} = 0.5A$$

A voltage of 1.8V across the infrared LED and current of 72mA were chosen.

$$9 = 72 \times 10^{-3} \times R_s + 1.8$$

$$R_s = \frac{9 - 1.8}{72 \times 10^{-3}}$$

$$= 100\Omega$$

Resistor  $R_s$  ensures long life of the Infrared LED by ensuring it is operated on a current of magnitude less than the infrared LED's maximum rating.

### 3.2 Infrared Receiver

The infrared receiver unit/control unit is built up from different sub-units.

1. The power supply unit.
2. The infrared receiver module.
3. The Logic Inverter.
4. The Toggle Flip Flop.
5. The Opto coupler.
6. The power switch (Triac).
7. Socket outlet.

Each sub-units are explained in details as follows:

#### Power Supply

The supplied power is gotten from a 240v 50Hz by the use of a step down transformer, that steps the voltage down to 12v, a four diode rectifier bridge is used in converting the voltage to a 12v dc, a capacitor goes after it in order to filter of noise, and any form of alternating current left, a 7805 voltage regulator IC is then used in stepping down the voltage from 12v to 5v. This 5v is then sent to sub-unit.

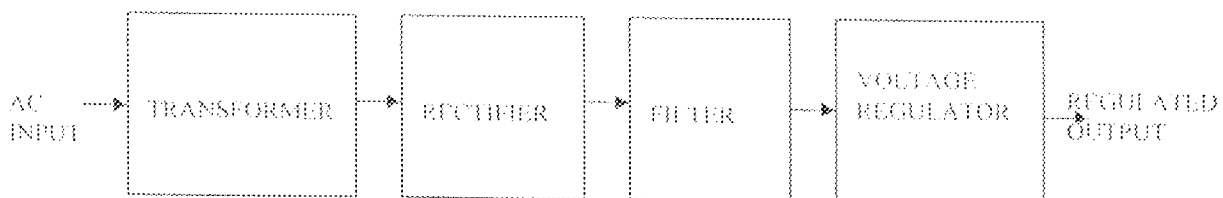

Fig. 3.9: Block Diagram of the Power Supply Unit.

### Transformer

The transformer is a step down type rated 240/12v. This implies that whenever a 240v a.c mains supply is applied to the primary of the transformer, a 12v a.c will be obtained at the secondary of the transformer.

From the rating of the transformer, the voltage transformation ratio ( $k$ ) can be calculated as follows:

Let  $V_S$  be secondary voltage and  $V_P$  be the primary voltage, then transformation ratio

$$k = \frac{V_S}{V_P} \dots \dots \dots (2)$$

Since  $V_S=12V$  and  $V_P=240V$ , the transformation ratio of the transformer from equation (2) is

$$\begin{aligned} k &= \frac{12}{240} \\ &= \frac{1}{20} \end{aligned}$$

Thus,

$$\begin{aligned} V_S &= V_P K \\ V_S &= \frac{V_P}{20} \end{aligned}$$

The transformer's form factor is obtained by

$$\begin{aligned}
 \text{formfactor, } f &= \frac{V_{rms}}{V_{dc}} \dots\dots\dots (3) \\
 &= \frac{V_{rms} \sqrt{2}}{2V_{max} / \pi} \\
 &= \frac{\pi}{2\sqrt{2}} \\
 &\approx 1.111
 \end{aligned}$$

The output of the transformer is fed into the bridge rectifier network to be rectified to dc. The transformer also provides isolation from the supply line which is an important safety consideration.

### Bridge Rectifier

This circuit employs four diode to convert a.c voltage into pulsating d.c voltage. The following are there advantage of selecting it in this design.

- No centre-tap is required on the transformer
- It is suitable for high voltage application
- Much smaller transformer are required
- It has less peak inverse voltage (PIV) rating per diode

### Rectifier Design Calculation

Efficiency of rectifier

$$\begin{aligned}
 \eta &= \frac{\text{Power}_{dc}}{\text{Power}_{ac}} \times 100\% \dots\dots\dots (4) \\
 &= \frac{\text{Voltage}_{dc}(V_{dc})}{\text{Voltage}_{rms}(V_{rms})} \times 100\%
 \end{aligned}$$

But

$$V_{rms} = 12V \text{ (From transformer specifications)}$$

$$V_{dc} = \frac{V_{max}}{\text{formfactor}}$$

$$V_{dc} = \frac{12}{1.11}$$

$$V_{dc} = 10.80V$$

Efficiency of the rectifier is then

$$\eta = \frac{10.80}{12} \times 100\%$$

$$\approx 90\%$$

Ripple content of the pulsating dc output

$$V_{r(rms)} = \sqrt{(V_{max}^2 - V_{dc}^2)}$$

$$V_{r(rms)} = \sqrt{(12^2 - 10.80^2)}$$

$$V_{r(rms)} = 6.51V$$

Ripple factor

$$\gamma = \frac{V_{r(rms)}}{V_{dc}} \dots \dots \dots (5)$$

$$= \frac{6.51}{10.80}$$

$$= 0.6451$$

$$\approx 64.5\%$$

The rectified dc output is passed through the filter for filtering

### Filter Capacitor

The main function of the filter capacitor is to minimize the ripple content in the rectified output voltage. The capacitor, C is connected across the rectifier output and in parallel with the voltage regulator to achieve filtering action. This type of filter is known as capacitor input filter.

The filter circuit depends, for its operation on the property of a capacitor to charge up during conducting half-cycle. In simple words, a capacitor opposes any change in voltage.

When connected across a pulsating d.c voltage, it tends to smoothen out or filter out the voltage ripples.

### THE VOLTAGE REGULATOR

The voltage regulator is an integrated circuit that is capable of maintaining a constant dc output voltage irrespective of variations of the ac input voltage and output load resistance. The voltage regulator used in this design is the L7805CV regulator which is a 3 pins integrated circuit having an input, common and regulated output terminals. The 7805 voltage regulator is shown below.

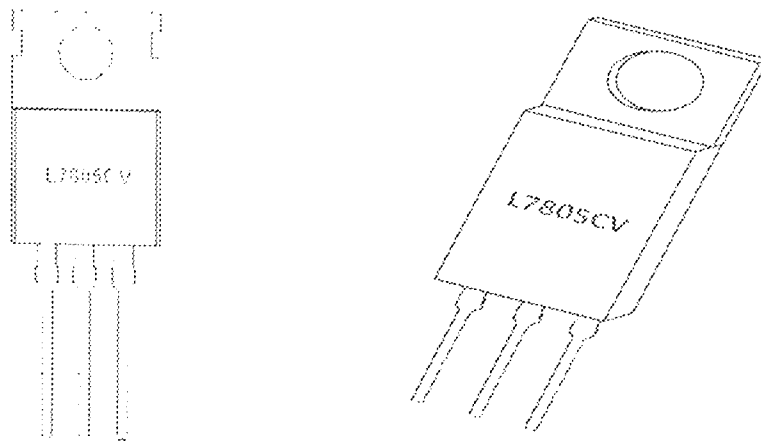

Fig.3.10: Voltage Regulator.

This voltage regulator provides a constant 5V dc supply at its output terminals which is more efficient to drive the infrared receiver circuit than a non-regulated supply.

### Infrared Sensor

An infrared sensor (TSOP1738) provides the interface between the receiver and transmitter. It is a three-terminal IR integrated circuit that receives the IR signal from the transmitting device. It has detection range of about ten meters and can detect a frequency of about 38KHz which is mostly generated by television remotes. The three pins represent the power pin, the common ground pin and the output pin of the receiver which is

connected to the inverting unit via capacitor of 40uf and a 10KΩ resistor, which both acts as a band pass filter. When no signal is received by the infrared receiver module, its output terminal produces a HIGH signal which is inverted to a LOW signal by the Inverting unit. This prevents the D-Flip Flop from being clocked. When the receiver module receives an infrared signal, its output produces a LOW signal which is inverted to a HIGH signal by the Inverting unit in the circuit. This HIGH output of the Logic Inverter then clocks the D-Flip Flop, enabling it to toggle its output. This operation ensures that the circuit only works when a signal is received by the receiver module from the transmitter.

### LOGICAL OPERATION OF THE NAND GATE

The nand gate produces a low output only when all the input are HIGH.[13] When any of the input is low, the output will be HIGH. For the specific case of a 2- input NAND gate with shmitt triggering, with input label "A" and "B" and the output labelled "X", the operation can be stated thus:

The output "X" is LOW if input "A" and "B" are HIGH if either "A" or "B" is LOW, or if both "A" and "B" are LOW.

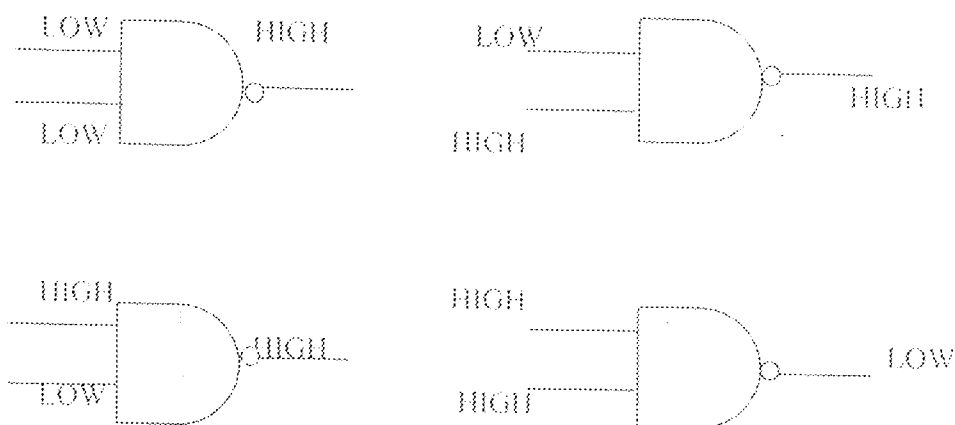

Fig 3.11: logical operation of a 2- input nand gate

Table 1; Truth table of a two input nand gate.

A(INPUT)	B(INPUT)	X (OUTPUT)
0	0	1
0	1	1
1	0	1
1	1	0

1= HIGH 0= LOW

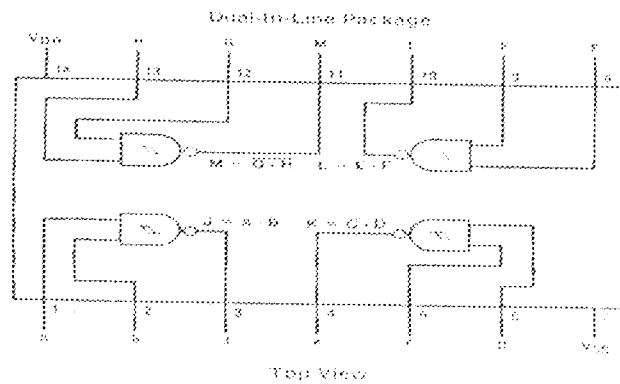

Fig 3.12: internal circuitry of a 4093 IC

Pin 1 and 2 are the input pins which was used, and its output being pin 3 was then connected to clock of the dual d flip-flop which was used. By this whenever there is no signal received on the infrared sensor, the sensor goes HIGH making the output of the pin 3 on 4093 IC go LOW, but when there is a signal received from a transmitter on the sensor, the sensor would go LOW making the output at pin 3 of the 4093 IC to go HIGH.



## THE D FLIP-FLOP

Flip Flops are memory elements which are made of an assembly of Logic gates connected together in a way that permits information to be stored. The Flip Flop used in this project is the D-Flip Flop, where the D stands for Data.

The symbol of the D-Flip Flop is shown below.

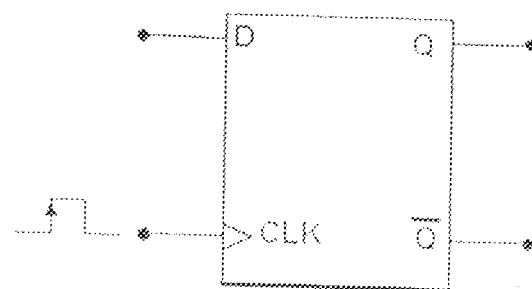

D=Data, CLK=Clock, Q =Output,  $\overline{Q}$ =Invert of Q output.

Fig.3.13: Symbol of D-Flip Flop.

The D-Flip Flop is an edge triggered Flip Flop, i.e. it changes its state either at the positive edge (rising edge) of the clock pulse or at the negative edge (falling edge) of the clock pulse for positive edge triggered and negative edge triggered D-Flip Flops respectively. It is sensitive to its input only at this transition of the clock.

The operation of the D-Flip Flop is such that the Q output goes to the same state as that is present on the D input when a rising edge occurs at the CLK input. In other words, the level present at D is stored in the Flip Flop at the instant the rising edge occurs. The truth table of a D-Flip Flop is shown in the next page.

Table 2: Truth Table of D-Flip Flop.

INPUTS		OUTPUT
D	CLK	Q
0	↑	0
1	↑	1

The operation of the clocked D-Flip Flop is explained by the input and output waveforms below.

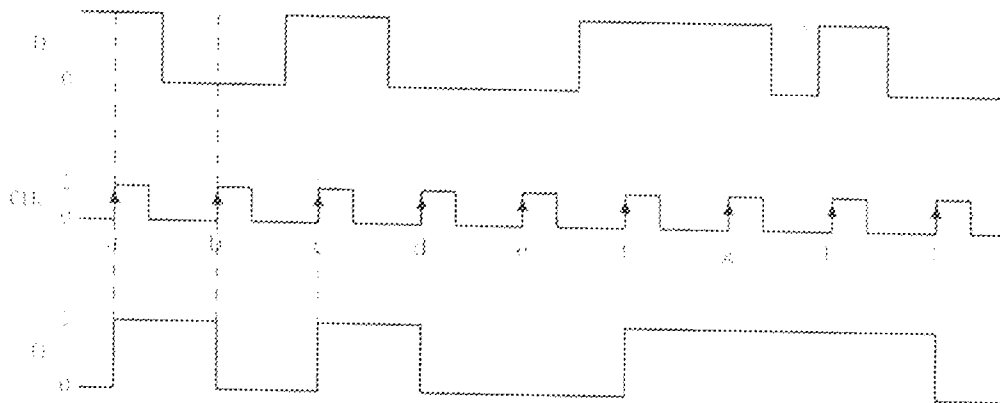

Fig. 3.14: Input and Output Waveforms of Clocked D-Flip Flop.

Assuming the  $Q$  output is initially 0. When the first rising edge of the clock pulse occurs (point a), the D input is 1, therefore,  $Q$  goes to the 1 state. Between points a and b, D input level changes but it has no effect on  $Q$ . The  $Q$  output stores the 1 that was on D at point a until another rising edge of the clock pulse occurs.

When the second rising edge of the clock pulse occurs (point b), D is 0 at that time and so,  $Q$  goes to 0 and remains 0 until another clock pulse occurs. Similarly,  $Q$  takes on the levels present on D when the rising edges occur at points c, d, e, f, g, h and i.

The toggle operation of the D-Flip Flop was achieved by connecting the  $\bar{Q}$  output of the D-Flip Flop to the D input as shown below.

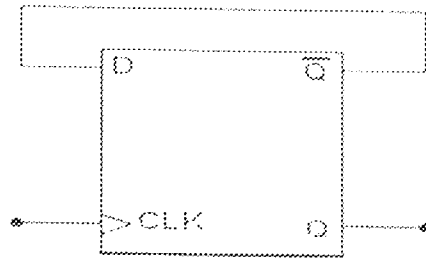

Fig. 3.15: Toggle Mode Connection of D-Flip Flop.

The waveforms for the toggle mode are shown below.

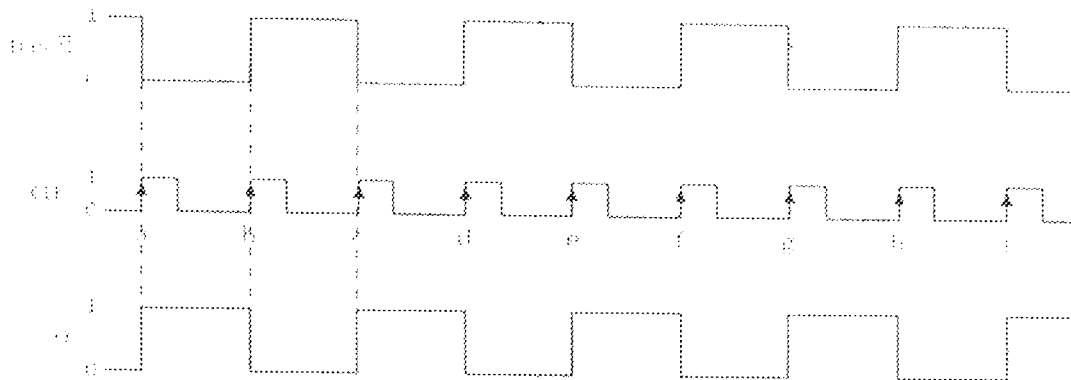

Fig. 3.16: Input and Output Waveforms of Toggle Flip Flop.

It can be seen from the waveforms above that at the recurrence of clock pulse a, b and c,  $\bar{Q}$  is present at D and the  $Q$  output is the opposite state of the D or  $\bar{Q}$  terminal. This is same for the d, e, f, g, h and i clock pulses. Also it can be seen that the  $Q$  output toggles its state on every positive edge of the clock pulse.

This  $Q$  output controls the switching operation of the infrared remote control receiver unit.

The Logic circuit (4013) used in this project is a Dual type D-Flip Flop IC. Only one of the two D-Flip Flops was used and other unused inputs (D, CLK) of the second D-Flip Flop were connected to ground while the unused outputs ( $\bar{Q}$ ,  $\bar{Q}$ ) were left open. This was done to achieve stable operation of the chip.

### THE OPTO COUPLER.

The opto coupler used is MOC3021 which is optically coupled isolators consisting of a Gallium Arsenide infrared emitting diode coupled with a light activated silicon bilateral switch performing the functions of a triac mounted in a standard 6 pin dual-in-line package. This device is used for interfacing between electronic controls and power control of resistive and inductive loads.

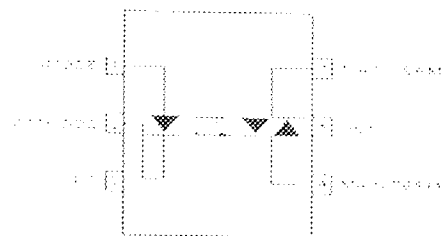

N/C=NOT CONNECTED.

Fig.3.17: Schematic Diagram of MOC3020 Opto Coupler.

The output of the D-Flip Flop was connected to the LED of the opto coupler while the light activated silicon bilateral switch was used to control the gate of the triac used in the circuit. When the output of the D-Flip Flop is HIGH, the LED in the opto coupler turns ON. The light from this LED activates the light activated bilateral switch of the opto coupler, thus allowing current flow to the gate of the triac. When the output of the D-Flip Flop goes LOW, the LED in the opto coupler turns OFF and the light activated silicon bilateral switch also deactivates, thus stopping current flow to the gate of the triac.

## THE POWER SWITCH.

The power switch used in the project is a triac. The Triac is a member of the thyristor family. But unlike a thyristor which conducts only in one direction (from anode to cathode) a triac can conduct in both directions. Thus a triac is similar to two back to back (anti parallel) connected thyristors but with only three terminals.

The triac used in this project is the AC10DT Triac. It has a voltage rating of 400V and current rating of 10A. The image of the AC10DT Triac is shown below.



Fig. 3.18: The AC10DT Triac.

Its operation is such that when the gate terminal is triggered, the diac in it is activated and there is current flow to the external circuit connected to it. When the trigger signal is removed from the gate terminal, the diac in the triac gets deactivated and the external circuit connected to the triac receives no current. The symbol of the triac is shown below.

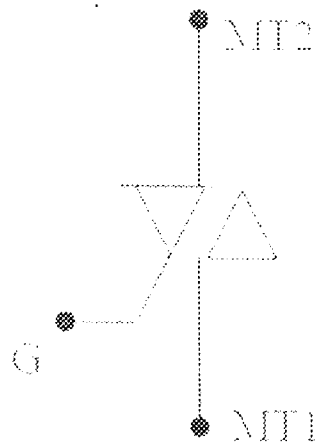

MT1=MAIN TERMINAL 1, MT2=MAIN TERMINAL 2, G=GATE

Fig. 3.19: Triac Symbol.

### SOCKET OUTLET

The socket outlet is used in supplying power to our appliance, the socket outlet its being triggered based on the action of the triac which is the switch controlling its state at any point in time. Because the rating of the switch is 10A, the maximum rating of any device intended to use in this project has to be a 10A devices or lesser than 10A.

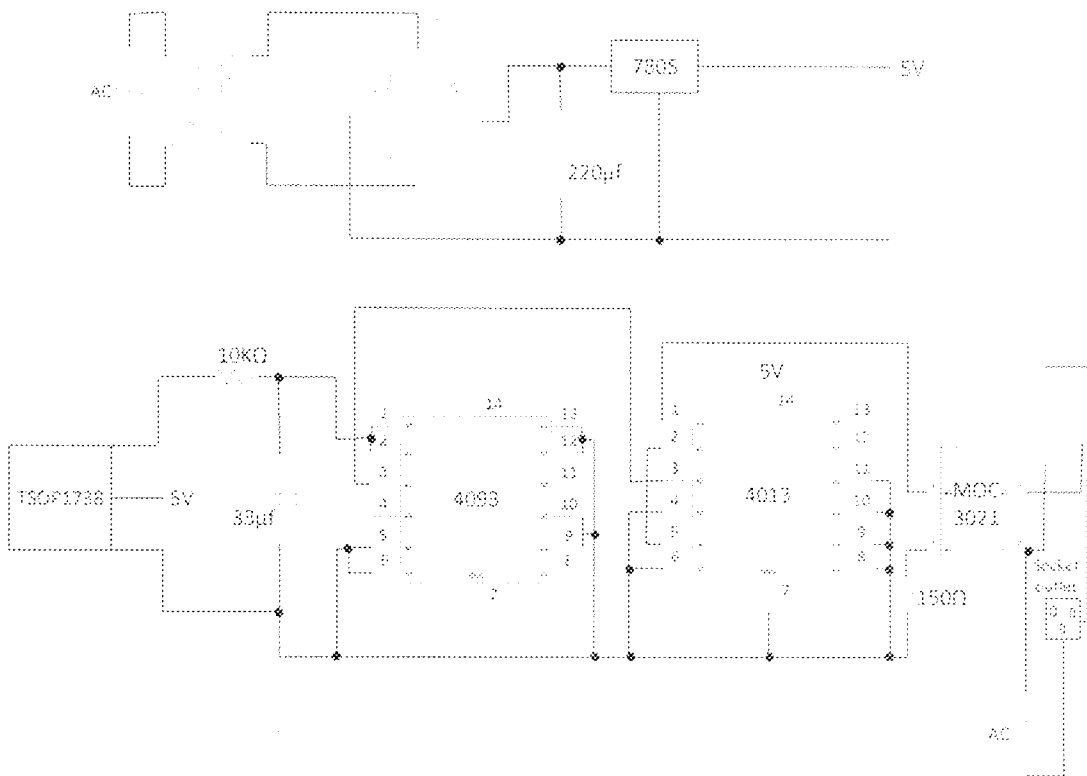

Fig 20: Circuit diagram of the receiver circuit.

## CHAPTER 4

### Test, Results and Discussion

#### 4.1 Construction Procedure and Precaution

The construction was carried out with outmost care. The precautions taken during the soldering were:

- Particular care was taken to orientate polarized component( e.g. electrolyte capacitor, transistor, diodes with respect to potentials.
- The components were laid out on a copper-tracked Vero board and soldered firmly in place.
- A fine gauge solder was used to solder the components together with care taken not to bridge the copper tracks lying side by side together.
- After each soldering, the tip of the soldering iron was cleared.
- Semiconductor components were soldered using a heat shunt so that devices like transistors and diodes would not be degraded in performance by excessive heat.

#### 4.2 Testing and Measurement

The testing was done with respect to the distance covered and operation as follows:

- The constructed Infrared transmitter was used in conjunction with receiver unit to determine the distance of coverage and this was done by placing the two units apart using a new battery and activating the ON/OFF button on the transmitter.
- The transmission was reliably detected when the receiver unit responds as it should by turning the lead ON and OFF.



- This was repeated for different spaces between the two unit and maximum distance above which inter-unit communication is not assured was 10 meters.
- The testing was done in such a way that the reflections from solid surfaces were eliminated as this would cause multiple reception path at the receiver end. This was achieved by accurately aligning the two units, establishing a line-of-sight contact.

#### 4.3 Photographic plates of the project and casings

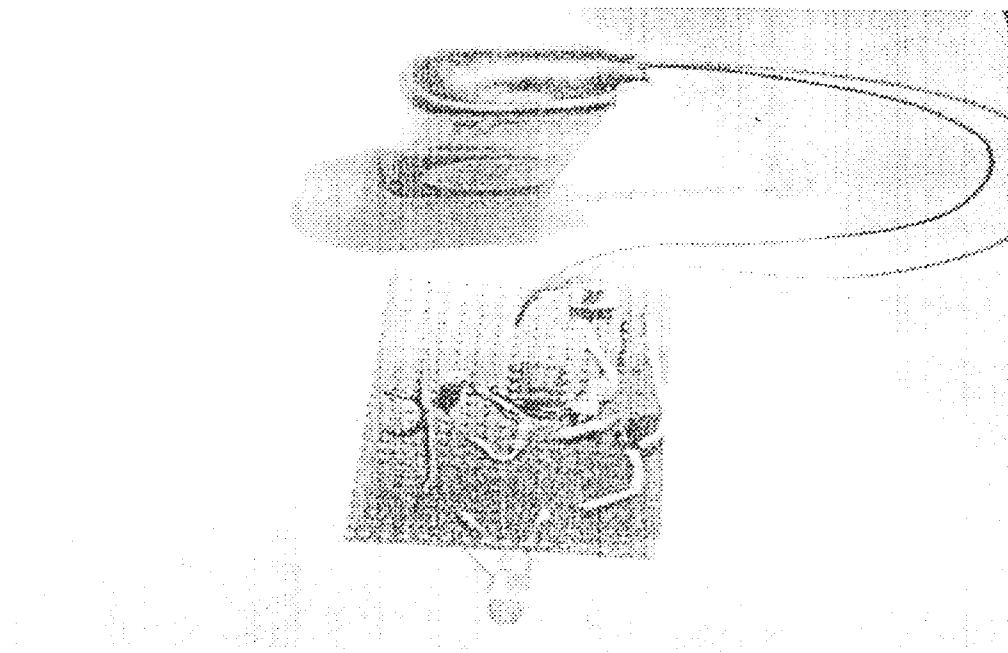

Fig 4.1 photograph of the transmitting circuit

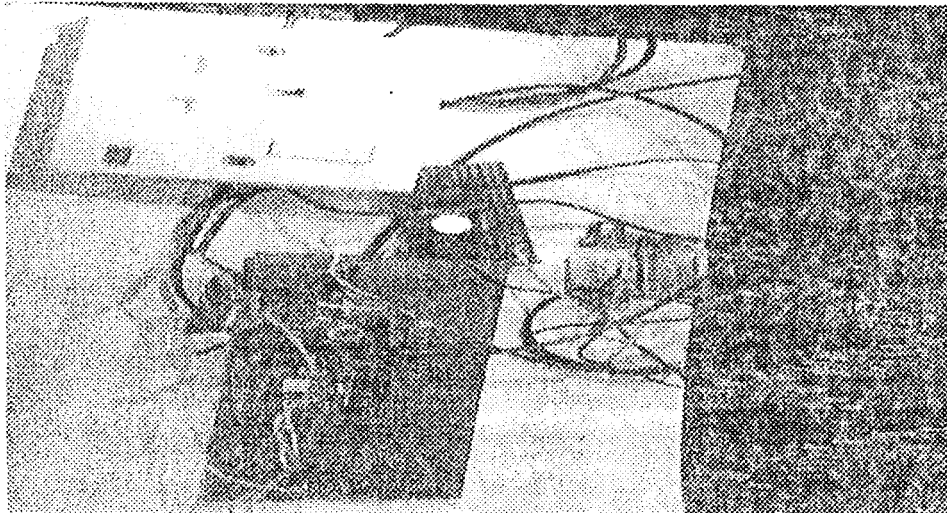

Fig 4.2 photograph of receiver wiring connection

#### 4.4 Results

An infrared link was reliably established between the transmitter and receiver unit and by extension, a convenience control for a remote load was achieved. This is in line with the objective of the project work.

#### 4.5 Limitations and Possible Remedy

Since there was no encoding used, the control is nonspecific with respect to the load to the controlled and this is evident in the deployment in which multiple loads are connected to the multiple receiver. If the receivers are placed fairly closed together, the signal meant for one load can be interpreted by the control meant for another load thereby causing multiple loads to respond to a signal meant for a particular load.

Encoding must be used if the control of the loads is to be specific. This ensures each load responds to its specific command.

#### 4.6 Problems Encountered

It was noticed that heavy power surges on the local mains supply cause erratic operation of the receiver unit. This is attributed to a corresponding surge on the d.c supply in or within the receiver unit. An LC combination noise filter was used on the ac line to remove high transients thereby ensuring more predictable operation.

The sensor was also found to be over sensitive. The sensor was therefore tamed by using a 40 $\mu$ F capacitor and a 1k $\Omega$  resistor connected across the output signal path of the receiver which consequently reduced the distance of operation between the transmitter and receiver by a slight degree.

## CHAPTER 5

### 5.1 CONCLUSION

The remote controlled socket outlet can be used for any electronic devices which are within and below the rating of the switch. Modifications can be made on the design and constructed socket outlet to be able to carry load of higher ratings. For the constructed remote controlled socket outlet, it will only carry any load at 10A and below. The remote control have an effective performance within the range of 2m anything farther than this its effectiveness is not certain.

### 5.2 RECOMENDATION

Due to the unreliable nature of the country's power supply a modification should be made for the socket outlet to automatically turn OFF as soon as there is power failure, so that when the power is being restored it would not go directly to any appliance connected to it, which may possibly cause damage.

## References

- [1] Wikipedia [http://inventors.about.com/od/rstartinventions/a/remote\\_control.htm](http://inventors.about.com/od/rstartinventions/a/remote_control.htm)
- [2] Electrical networks design and installation in building (By Prof Oria Usifo)
- [3] Library.[thinkquest.org/historyofremotecontrol](http://thinkquest.org/historyofremotecontrol)
- [4] Jonnes, Jill. Empires of Light ISBN 0-375-75884-4, Page 355, referencing O'Neill, John J. Prodigal Genius: The Life of Nikola Tesla (New York: David McKay, 1944)
- [5] "Philco Mystery Control". <http://www.philcorepairbench.com/mystery/index.htm>.
- [6] "Five Decades of Channel Surfing: History of the TV Remote Control". Archived from the original on 2008-01-16 [http://web.archive.org/web/20080116212531/http://www.zenith.com/sub\\_about/about\\_remote.html](http://web.archive.org/web/20080116212531/http://www.zenith.com/sub_about/about_remote.html). Retrieved 2008-12-03
- [7] "The Inventor Who Deserves a Sitting Ovation." Washington Post, February 17, 2007
- [8] "SB-Projects: IR remote control: IIT protocol". <http://www.sbprojects.com/knowledge/ir/iit.htm>
- [9] "Celadon Remote Control Systems Company Profile Page".
- [10] "Jakob Nielsen's Alertbox: Remote Control Anarchy". <http://www.useit.com/alertbox/20040607.html>.
- [11] MLA Style: "infrared radiation." Encyclopædia Britannica. Encyclopædia Britannica 2008 Ultimate Reference Suite. Chicago: Encyclopædia Britannica, 2008.
- [12] [www.datasheetcatalog.com](http://www.datasheetcatalog.com)
- [13] A text book of ELECTRICAL TECHNOLOGY in S.I. SYSTEM OF UNITS BY B.L. THERAJA AND A.K. THERAJA Revised By: S.G. TARNEKAR. First edition 1959. ISBN: 81-219-2441-3. Code : 10 291

# COMPLETE CIRCUIT DAIGRAM OF AN IR REMOTE CONTROLLED SOCKET OUTLET

