



Offshore Topside Rotating Packed Bed as Process Intensified Alternative for Natural Gas Sweetening and Dehydration

Adegboyega Bolu Ehinmowo^{1,2*}, Aliyu M. Aliyu^{2,3},
Solomon O. Alagbe⁴, Oyewole Adedipe^{5,6} and Olufunke Olumi¹

¹Petroleum and Environmental Management, Coventry University, United Kingdom.

²Oil and Gas Engineering Centre, Cranfield University, Bedfordshire, University Kingdom.

³Department of Chemical Engineering, Federal University of Technology Minna, P.M.B. 65,
Niger State, Nigeria.

⁴Department of Chemical Engineering, Ladoko Akintola University of Technology, P.M.B. 4000,
Ogbomoso, Oyo State, Nigeria.

⁵Offshore Renewable Energy Centre, Cranfield University, Bedfordshire, United Kingdom.

⁶Department of Mechanical Engineering, Federal University of Technology Minna, P.M.B. 65,
Niger State, Nigeria.

Authors' contributions

This work was carried out in collaboration between all authors. Authors ABE and OO designed the study and performed simulations; author AMA wrote the first draft of the manuscript. Authors SOA and OA managed the literature searches and proofread all drafts. All authors read and approved the final manuscript.

Article Information

DOI: 10.9734/ACSJ/2015/19157

Editor(s):

(1) Francisco José Hernández Fernández, Department of Chemical and Environmental Engineering,
Technical University of Cartagena, Spain.

Reviewers:

(1) Anonymous, Universiti Malaya, Malaysia.

(2) Anonymous, Autonomous University of Queretaro, Mexico.

(3) Anonymous, Universiti Teknologi Petronas, Malaysia.

Complete Peer review History: <http://sciencedomain.org/review-history/10247>

Original Research Article

Received 28th May 2015
Accepted 11th July 2015
Published 19th July 2015

ABSTRACT

This work is aimed at investigating the benefits of replacing conventional process unit operations with process intensified ones in offshore applications. This ensures that better use is made of raw materials, lower energy consumption and a reduced plant volume was achieved. Specifically, a rotating packed bed technology has been used for gas dehydration and sweetening. To achieve

*Corresponding author: E-mail: adeehinmowo@yahoo.com;

the aim of this study, a process intensification approach is used to redesign mature absorption processes to more compact and efficient one. Process simulation using Aspen Hysys was carried out for Triethylene glycol dehydration and monoethanolamine sweetening. More than 36-fold absorption unit size reduction was achieved thereby effecting large decrease in capital and operating costs compared to the conventional packed columns currently utilized in the offshore oil and gas industry. The process intensified technologies therefore can be deployed for offshore applications where space and size considerations are of utmost importance.

Keywords: Process intensification; offshore oil and gas; absorption; gas sweetening.

1. INTRODUCTION

There has recently been an increase in exploitation of unconventional reserves such as shale gas, tight oil and tar sand by the production sector of the oil and gas industry. These unconventional reserves require complicated processing and therefore will be expensive to produce using conventional methods. The offshore oil and gas production and processing sectors are faced with a host of challenges coupled with volatile global energy demand. Some of these challenges have been identified as remote locations, harsh environments, extreme climates, and weight and size constraints. The recent fall in oil prices has further heightened the need for solutions which are safe, effective, cost-efficient; robust enough to ensure reliability and availability of equipment in hostile environments and have minimal impact are therefore required to overcome all these challenges.

Process intensification can help address some of these issues by using systems which are energy efficient and use of minimal space [1]. Process intensification was pioneered in the 1970s by Colin Ramshaw [2] and can particularly lead to the manufacture of products which could hitherto be produced by conventional process technology with radical process performance enhancements [2].

The use of industrial High gravity (HiGee) technologies began in the late 1970s when Imperial Chemical industries (ICI) started working on spinoffs of NASA research projects on microgravity environments [3,4]. Ramshaw and his team at Imperial Chemical Industries (ICI) developed the HiGee technology but later licensed it to Glitsch in the USA based on their vast experience with conventional distillation and absorption equipment [5]. Initially, Ramshaw [3] thought up to 100-fold reduction in equipment size could be achieved using HiGee for distillation. However, experimental studies in [6]

and [7] revealed only a 5-10-fold reduction in height equivalent theoretical plate (HETP).

Rotating packed Beds (RPB), a type of HiGee reactor make use of highly porous packing material with high specific surface area compared to similar packing used in conventional towers [8]. Research carried out in [9,10,11,12] all refer to HiGee, carried out in a rotating packed bed (RPB) as an advanced process intensification technology. Due to the excellent mass transfer performance; RPBs have been extensively studied for gas absorption. Liquid flowing through the packing in a typical RPB operation is subjected to an acceleration of at least 300 m/s^2 tuned by the rotational speed. The high-gravity environment enables the RPB to be operated at higher gas and liquid flow rates which significantly increases the production capacity and reduces the volume of the apparatus [12]. HiGee technology an acronym of high gravity is emerging as an alternative to conventional tray and packed towers for mass-transfer applications [13].

As a high centripetal field is used inside the reactor, the material used as the packing must be able to withstand the forces generated [8]. A study by Wang et al. [14], proposed that substitution of centrifugal force for gravitational force in HiGee could bring about a very high volumetric mass transfer that would allow the physical size of the equipment to be much smaller thereby reducing capital and operation costs. To further support this, it was reported [12] that the key point of the HiGee technology relies on the stimulated high-gravity environment created by the centrifugal force of the RPB. Two RPBs accumulated several thousand hours of trouble-free running in a study of mass transfer performance at total reflux for iso propanol/ ethanol system. As the centrifugal force of RPB can be several hundred times the gravity, some benefits can be attained such as very high mass transfer efficiency, reduced tendency to flooding, resistance to moderate disturbance and

inclination. These benefits make RPB an attractive alternative for mass transfer operations [13].

Gas and liquid flow within the reactor is usually counter current as shown in Fig. 1. One phase is injected from the periphery of the rotor and percolates through the packing. The other phase enters from the centre of the rotor and is flung by the high centripetal field generated by RPB towards the packing. A high transfer rate can be expected due to the thin film between the gas-liquid phases [15]. Thin liquid films are generated in the RPB and the interface between the gas/liquid or liquid/liquid is violently renewed thus a significant intensification of mass transfer and macro-mixing occurs [12]. To further support this findings, Wang et al. [13], described a typical RPB as a rotor made of packing and the auxiliaries which include casing, shaft, liquid distributor and inlet/outlets. The liquid is fed through a distributor onto the inner side of the rotor and flows radially outward as thin films, rivulets or droplets by centrifugal force. The gas enters into the rotor at the outer side and flows radially inward by pressure gradient. The gas and liquid counter-currently contacts in the rotor wherein mass transfer takes place.

Reay et al. [16] suggested that to prevent accumulation within the rotor due to the high throughput of liquid, the drainage point should be capable of draining all the fluid. The RPB is able to contain over 20 theoretical distillation stages in the 25 cm packing once improvements to the liquid distribution to ensure uniformity were made. RPBs not only utilize high voidage but also exploit high centripetal forces for use in intensifying transport processes such as mass and heat transfer. According to [5], RPBs have a magnitude of acceleration much greater than that of gravity. The acceleration within a given centripetal field is given by $g = \omega^2 r = ng$ (ω is RPB rotational speed in rad/s, r is radius of rotation and n is integer number of times of gravitational acceleration) with typical examples of RPB with surface areas of 500-5000 m^2/m^3 , voidages greater than 85% and highly uniform packing provided in [17]. Kolev [18] proposed a surface area of 1000-4000 m^2/m^3 .

Flooding which is connected to the classic Sherwood flooding correlation was discussed in [19,20]. Sherwood flooding correlation is used to describe fluid behaviour which runs counter current to the gas vapour. The amount of

interfacial interaction increases with increase in flow of fluid. The point when flooding is said to be occurring is when liquid accumulates in the column as its path outwards from the centre is obstructed and movement of the fluid outwards is increasingly difficult and eventually stops. At this point the reactor mass transfer efficiency drops and is said to be absent.

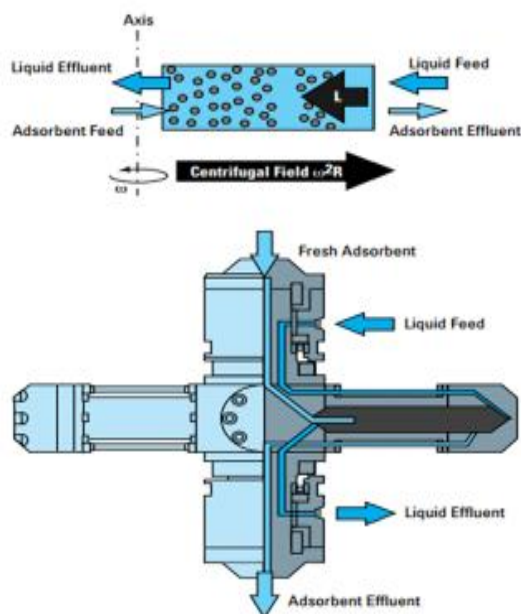

Fig. 1. Process intensification example: Centrifugal adsorber [21]

When considering enhancement of transport processes like mass transfer, an important consideration is the upper flooding limit. To establish the flooding conditions of the reactor a series of experiments at different gas and liquid flow rates are used for a new RPB. Flooding will tend to occur faster at the inner radius in contrast to flooding within a packed tower where flooding is simultaneously achieved throughout the packing [16].

Peel et al. [5] report that success was achieved in providing a more cost effective and efficient method of stripping oxygen from sea water. A more recent use of stripping operations with RPB which was reported in [22] is the removal of ozone from gaseous feeds. Other applications of RPB include mass transfer studies with a variant of the RPB in the form of a rotating solid foam reactor and absorption of compounds such as Volatile Organic Compounds (VOC) reported in [12].

A wide range of application areas have been found in the chemical industry for HiGee process intensified units. These include steel slag carbonation, removal of carbon dioxide from indoor air, and post-combustion carbon capture in power plants, rotary disc solvent extraction, and spinning disc polymerisation. Zhang et al. [23] showed that higher product quality and process efficiency can be achieved using HiGee reactors for on-site surfactant sulphonation used for enhanced crude oil recovery. They reported outstanding intensification effects on diffusion and micro-mixing of HiGee technology in such applications while noting the superiority over conventional processes.

Although Process intensification has many benefits and successful commercial applications, there still exist some barriers or obstacles which are hindering the advancement and implementation. The adoption of HiGee in the oil and gas industry has been limited due to commercial rather than technical reasons because oil industries are concerned with the difficulty of competing with existing equipment [5]. The Growth of the process industry is through trade instead of research and development. Instead of investing in risky long term development projects, companies are focusing on short-term business targets. A high technical and financial risk of implementing PI technologies is making companies to seek opportunities through optimization of business work processes. Plant managers are hesitant to be the first to take risks because many of these technologies have not been proven in industrial scale even though they have been developed and studied in universities and research companies [24]. It is evident that process intensified technologies possess potential benefits which can be harnessed in the oil and gas industry. This work therefore is aimed at investigating the benefits of replacing conventional process unit operations with process intensified ones in offshore applications.

2. METHODOLOGY

Aspen HYSYS V7.3 was used to simulate the Triethylene glycol (TEG) dehydration and Monoethanolamine (MEA) sweetening units in order to analyse the performance of conventional absorber and regeneration columns. The RPB sizes were developed with the sizing equations from [25] using stream flow rates and other

properties from the conventional process simulation.

2.1 HYSYS Simulation for TEG Dehydration and Gas Sweetening Using MEA

The first step involved is defining the simulation bases which are respectively 12450 kgmol/h of TEG and 12380 kgmol/h of MEA feed. The Glycol and Amine Fluid Packages were respectively selected. The TEG dehydration process flow diagram simulation environment is as shown in Fig. 2. Wet gas is fed into the contactor and most of the water vapour in the gas is absorbed in the highly hygroscopic glycol. The rich glycol is withdrawn from the contactor bottom and routed to the heat exchange coil otherwise known as the still or Lean/Rich (L/R) heat exchanger here. Regenerated glycol from the regenerator at a higher temperature is fed into the tube side and heat exchange here brings about reflux for moisture separation and also heats up the rich glycol prior to regeneration. Sour gas rich in moisture is collected at the regenerator overhead while the regenerated MEA boosted by the glycol pump to the pressure of the contactor and recycled as contactor feed.

Of importance is the convergence of the contactor absorber and regenerator. The top and bottom temperatures and pressures of the absorber were specified while the regenerator convergence was facilitated by specifying the condenser and reboiler pressure, the reflux ratio and the vent rate. For the Gas sweetening (Fig. 3), the feed properties were taken from [26] at a temperature of 303K and 70 bar pressure and contains 0.0152 mol% of hydrogen sulphide which is to be absorbed in MEA in the contactor and the sweet gas collected.

The H₂S-rich MEA from the contactor is passed over an expansion valve V-2 and the low pressure rich MEA is fed into the flash tank and vapours are collected overhead while the even richer MEA is preheated in the L/R HEX and fed to the regenerator column. Negligible pressure drop was assumed in the amine-amine heat exchanger to aid convergence. Regenerator bottoms lean in H₂S are used as the preheating stream in the L/R HEX while the overhead product is condensed acid gas. Stream properties and pumping requirements were appropriately extracted and used for design and costing of the process intensified alternative, the RPB.

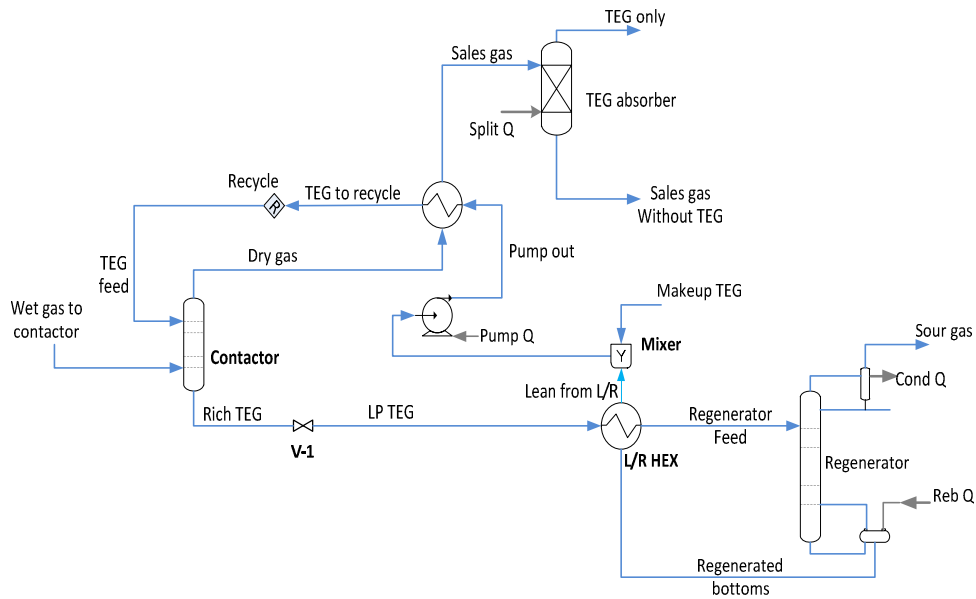

Fig. 2. Process flow diagram for TEG dehydration

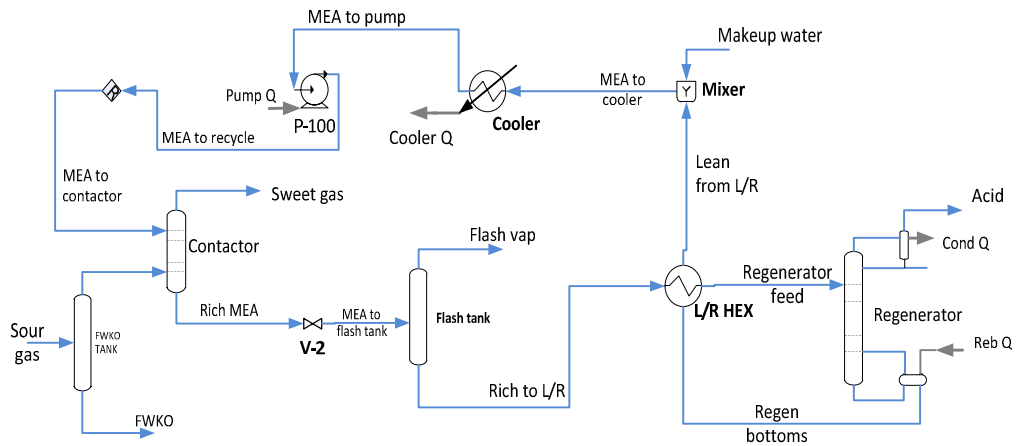

Fig. 3. Process flow diagram for sour gas sweetening using MEA

2.2 Rotating Packed Bed (RPB) Sizing

If V_{jet} denotes the liquid jet velocity and f_d is the fraction of the packing inner radius that the liquid distributor occupies which is usually between 1/4 and 1/3, the RPB inner radius for a liquid jet to exit gas kinetic energy ratio of p , recommended to be approximately 4 is obtained as

$$r_i = \left[\frac{G}{\pi V_{jet} (1 - f_d)} \right]^2 \left[\frac{\rho_G P}{\rho_L} \right]^{\frac{1}{4}} \quad (1)$$

Where P is the column pressure. Higher values are not recommended hence a liquid jet velocity between 4 and 5 m/s is chosen to avoid the jet from splashing back when it hits the packing. The appropriate liquid jet kinetic energy is given so that the RPB inner radius is as small as possible. From the volumetric gas flow rate G , the RPB width is calculated as

$$h = \frac{G}{2\pi r_i U_G} \quad (2)$$

Where

$$U_G = \left[\frac{\beta N_g^a a_p^b \mu^c (\rho_L - \rho_G)^{0.25}}{\left(\rho_G^{0.5} + \lambda \left(\frac{L}{\alpha G} \right)^{0.5} \rho_L^{0.5} \right)} \right]^2 \quad (3)$$

Where a_p is the specific surface area of packing and μ is the fluid viscosity, the indices a , b , c , and the factors β , λ are regression parameters. Performing material balance on a differential annular shell for the primary component can be used to find the RPB outer radius

$$dy = K_{OG} a_c (y^* - y) 2\pi r h dr \quad (4)$$

The overall volumetric mass-transfer coefficient, $K_{OG} a_c$ is related to the gas side mass transfer coefficient $k_g a_c$ and liquid side mass transfer coefficient $k_l a_c$ as follows

$$\frac{1}{K_{OG} a_c} = \frac{1}{k_g a_c} + \frac{m c_g}{c_l (k_l a_c)} \quad (5)$$

For uniform liquid distribution onto the RPB with near complete wetting, the liquid distributor is designed. The total number of holes in the distributor (n) satisfies a minimum number of jets per square inch of the RPB inner periphery area to be wetted (J_{min}).

$$n = \text{round} \left(2\pi r_i h / J_{min} \right) \quad (6)$$

3. RESULTS AND DISCUSSION

3.1 RPB Column Sizing

Due to the enhancement in mass transfer, RPBs are characterised by easy operation and high efficiency. Stankiewicz and Moulijn [27] observed that their maximum economically, and technically feasible size is an overriding and determining factor for industrial application. Hence, a minimum number of sieve tray units are to be determined based on the required throughput defined by the input streams. These correspond to the number of separation stages required for a specified separation quality. Table 1 shows the

number of stages, and stream properties obtained from the simulation of the TEG and MEA processes using conventional unit processes. These are used as input parameters for the RPB design following [25].

The basic dimensions of the RPB to be determined in order to accomplish the given separation task are the inner and outer packing radii (r_i and r_o respectively) and the axial width (h). A liquid jet velocity of 5 m/s is chosen, fraction of packing value of 0.30 and liquid jet to exit gas kinetic energy ratio of 4. All these values have been chosen based on recommended ranges in literature. As it is a low-viscosity liquid, the value of coefficients and powers in the flooding correlation as given in [28] were selected.

$$(\beta = 130, a = 0.43, b = -0.93 \text{ and } \lambda = 1.51)$$

Selection of the packing material is a very vital consideration in HiGee design. Since the high centrifugal acceleration permits the use of packing with a large specific surface area in the range of 1000-4000 m^2/m^3 [18], a value of 3500 m^2/m^3 was chosen. The RPB rotational speed (in rpm) is a design degree of freedom which can be adjusted. The practical- industrial scale unit is between 1000 and 2000. A design rpm of 1500 was considered reasonable here. Fig. 4 shows the sizes of the columns for the conventional technology and Process intensified RPB technology. Comparing the conventional technology with HiGee, there is significant volume reduction in the sizes of the columns.

The sizes obtained for the RPB columns for both dehydration and sweetening are very small compared to the conventional columns currently used in offshore operations. The results obtained in this research (Table 2) are in agreement with the work reported in [25] which also shows size reduction in the use of HiGee. Although only the gas sweetening was considered, the size of the RPB used for pilot plant facility in [29] also validates the result achieved in this work. Agarwal et al. [25] wondered why this technology has not been well accepted in the industry despite the appeal it presents in the form of obvious reduction in capital costs. In their opinion, complexity and safety issues related to rotating equipment hinder wide industrial use. For example in situations where hazardous chemicals are involved, spillages will have to be prevented by all means and as such robust seals are needed and the costs could be excessively

high. However for offshore applications where overriding considerations, this technology is expected to receive considerable acceptance. The results in this study might provide a compelling pointer in this direction.

The small sizes obtained clearly confirms the estimation of achieving up to 100-fold reduction in equipment size [3] using HiGee for distillation and the description of process intensification requiring a small footprint compared to conventional equipment [30].

A case study of CO₂ absorption was considered in [24], where the CO₂-MEA absorption

space, size and cost are increasingly becoming equilibrium was modelled using the solubility data provided in [31] and as shown in Fig. 5, it shows a 20-fold absorber height reduction compared to the more than 36-fold reduction reported for this study. Similarly, [32] reported high separation efficiency in a reduced bed volume for a rotating packed bed distillation column. They discovered that the mass transfer coefficient depends on the liquid flow rate and rotating speed resulting in a 15.1 fold increase over the conventional technology. For the same degree of separation corresponding to equal number of transfer units, an 8–15 fold decrease in Raschig ring packing was required.

Table 1. Simulation result summary with conventional tray column

Gas stream	Property	TEG	MEA
	Temperature (°C)	30	25
	Pressure (kPa)	6200	6900
	Flow rate (kgmol/h)	12450	12380
Contactor	Type	Sieve tray	Sieve tray
	No. of trays	8	20
	Spacing (m)	0.6096	0.6096
	Sectional area (m ²)	3.083	4.670
Regenerator	No. of trays	1	18
	Spacing (m)	0.6096	0.6096
	Sectional area (m ²)	2.030	3.083

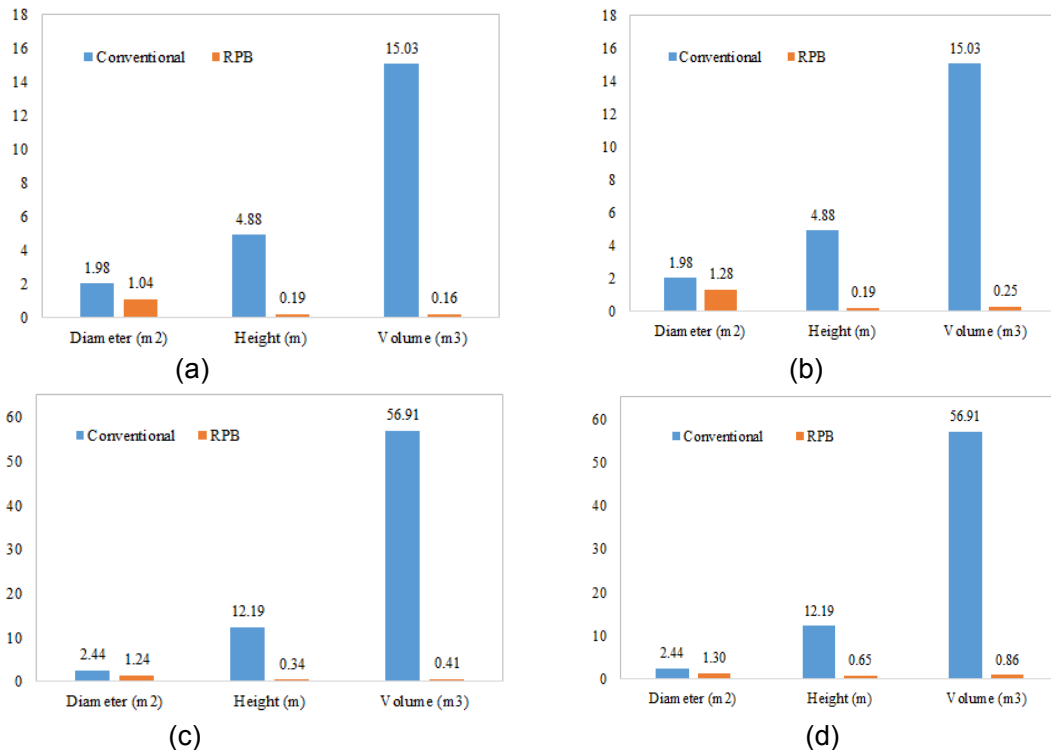

Fig. 4. Size comparison between conventional plate column and RPB for (a) TEG contactor (b) TEG regenerator (c) MEA contactor (d) MEA regenerator (diameters/heights in m, volume in m³)

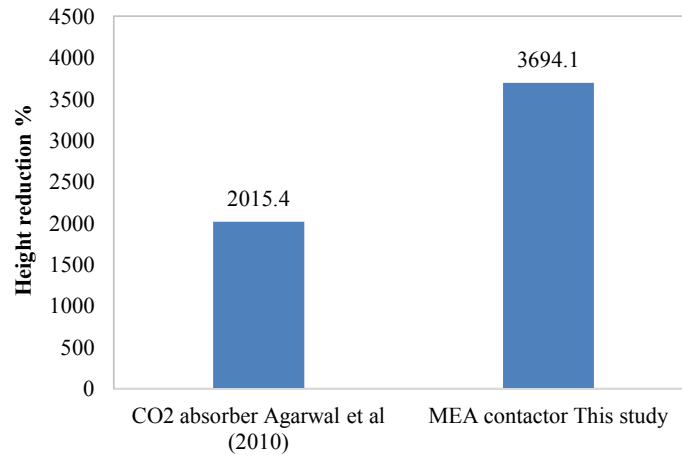

Fig. 5. Height percentage reduction compared to conventional

Table 2. Size of rotating packed beds (RPB)

	Property	TEG	MEA
Contactor	Inner radius (m)	0.11	0.21
	Width (m)	0.186	0.34
	Outer radius (m)	0.52	0.62
Regenerator	Inner radius	0.16	0.19
	Width	0.193	0.28
	Outer radius	0.64	0.65

RPB design considered a rotational speed variation of 1000, 1200, 1400, 1800 and 2000 rpm. The effect of the rotational speed on the centrifugal to gravitational acceleration for all columns considered is shown in Fig. 6. It can be seen that for all process units (TEG and MEA absorbers and regenerators) centrifugal to gravitational acceleration is increasing with the rotational speed. This is a proportional relationship between the rotational speed and the centrifugal to gravitational acceleration generated. The highest acceleration achieved was in the MEA absorber with the least being the TEG absorber for all rpms. The specific surface area is varied at 1000, 2000, 3000 and 4000 m^2/m^3 . The effect of the specific surface area on the axial width for all columns considered is shown in Fig. 7. The axial width is decreasing with increasing specific surface area. This is because the larger surface area of packing material provides more active sites for mass transfer hence less is required.

3.2 Sensitivity Analysis of RPB Parameters

Generally, there are various design considerations in order to acquire optimum result. The preliminary design for this research is a rotational speed of 1500 rpm and a specific area of 3500 m^2/m^3 . To further investigate the effect of these parameters, a sensitivity study was carried out. The process analysis for the

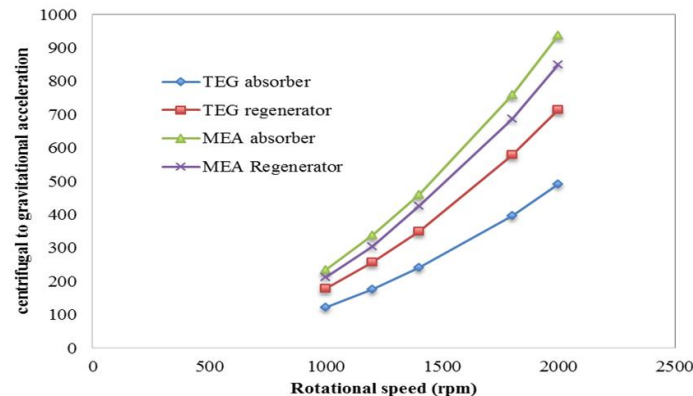

Fig. 6. Centrifugal to gravitational acceleration at different rotational speeds for MEA regenerator column

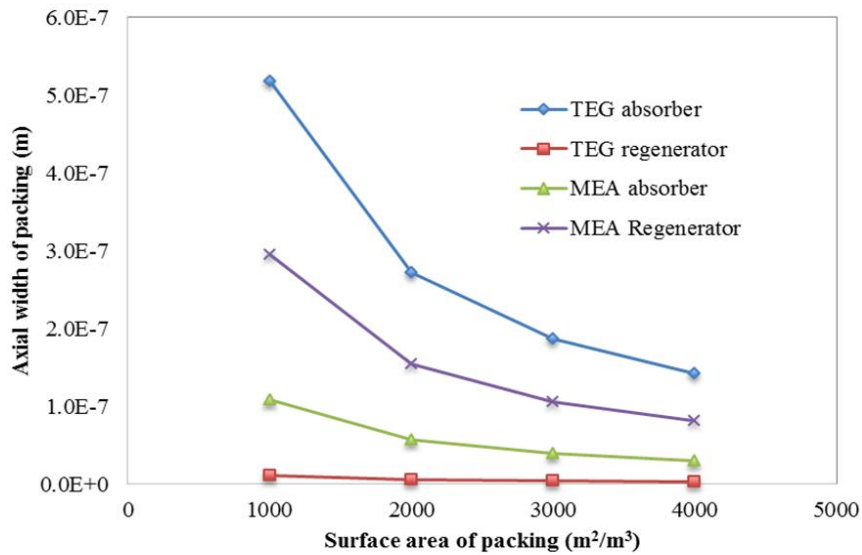

Fig. 7. Axial packing width at different surface area of packing for MEA Regenerator column

The effect of using different packing surface areas per cubic meter on the packing axial width required is shown in Fig. 7. The trends for the respective units are similar with the TEG absorber having a more pronounced effect of varying surface area and remain fairly constant for the TEG generator. The axial width of the packing is decreasing with increasing specific surface area, indicating more area available for mass transfer. Hence, more absorption and regeneration occurs with smaller columns. For a rotational speed of 1000, 1200, 1400, 1800 and 2000, the outer diameter of the columns is decreasing as the rotational speed is increasing in Fig. 8. This shows the effect of the rotational speed on the outer diameter.

Fig. 8 shows the effect of the rotational speed on the outer diameter for the absorber and regenerator columns. The outer diameter is decreasing as the rotational speed is increasing. Considering the RPB contactor for TEG, a rotational speed of 1000 rpm gives an equivalent outer radius of 0.88 m while a speed of 2000 rpm gives a smaller outer radius of 0.235 m. This means the higher the speed, the smaller the column which will encourage space saving and effective reduction in the cost of equipment. The effect of the rotating speed reflects the magnitude of the simulated gravity level inside the RPB as earlier highlighted in [23], which implies that the degree of flow turbulence affects the mixing taking place in the column.

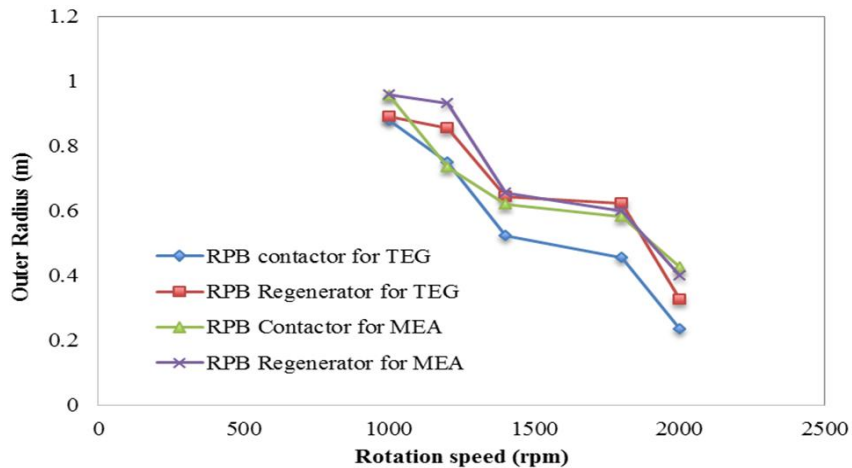

Fig. 8. Outer diameter dependence on rotational speed

Summarily, in conjunction with process integration, process intensification has been identified as one of the key technologies in cutting greenhouse gas emissions. It was highlighted in [33] that overall plant intensification in the UK has a potential of 40 PJ/ year (about 1 million tonnes of oil equivalent/annum). The total possible energy savings due to investment in process intensification in a range of process unit operations have been projected to be over 74 PJ/year (1 PJ = 1015 J). Forecasts for The Netherlands show that savings of 50–100 PJ/year ought to be realized across chemicals and food processing by the year 2050. Considerable benefits to industry in terms of less carbon footprint have been emphasized by US Department of Energy studies in the United States.

On the issue of process safety, many PI technologies require higher energy inputs or to be operated at higher temperatures. The processes may be more complex in terms of piping hence equipment failure/operator error, or call for a more complex control system. Fouling can also be an issue possibly leading to high pressures. For these reasons, both the process (including the chemistry, where appropriate) and plant need to be considered holistically to achieve a complete understanding of the safety issues [34].

Finally, as [35] have observed, it is worth mentioning that process intensification is wholly in development and, hence, the essential characteristics are still a subject of deliberation both in academia and the industry. Nevertheless, the innovative character of process intensification is in a pleasant harmony with the objectives of process systems engineering: indeed the prospects of a synergy between them have the potential to produce massive benefits.

4. CONCLUSION

This research has appraised the benefits of substituting conventional processes on an offshore production platform with process intensified technologies. It has been shown that the Rotating Packed Bed technology can adequately substitute the gas dehydration and sweetening absorber and regenerator columns. A significant (in some cases more than 30-fold) size reduction was shown to be achieved using the process intensified technology which in practice translates into huge capital cost savings and possibility of substantial reduction in carbon

footprint. Such size reductions are possible due to enhanced mass transfer occasioned by high gravity operation. Also, this study has provided a useful insight into the compelling benefits of size and cost reduction which meet part of the overriding considerations for offshore facilities as oil and gas activities shift more and more towards deep offshore operations.

COMPETING INTERESTS

Authors have declared that no competing interests exist.

REFERENCES

1. Howard G. Process intensification in industrial wastewater treatment. *Chemical Industry Digest*. 2012;56-63. (Online). Available:<http://www.fwc.com/publications/tech> [29 July 2013]
2. Kiel FJ. Modelling of process intensification. Weinheim, Germany: WILEY-VCH Verlag GmbH & Co. KGaA; 2007.
3. Ramshaw C. HiGee distillation- an example of process intensification. *Chemical Engineering*. 1983;389:13-14.
4. Ramshaw C, Mallinson RH. Mass transfer apparatus and its use, European patent 0,002,568; 1984.
5. Peel J, Howarth CR, Ramshaw C. Process intensification: HiGee seawater deaeration. *Tans I Chem E*. 1998;76:585-593.
6. Kelleher T, Fair JR. Distillation studies in a high-gravity contactor. *Ind. Eng. Chem. Res*. 1996;35:4646-4655.
7. Lin CC, Ho TJ, Liu WT. Distillation in a rotating packed bed. *Journal of Chemical Engineering, Japan*. 2002;35:1298-1304.
8. Burns JR, Ramshaw C. Process Intensification: Visual study of liquid maldistribution in rotating packed beds. *Chemical Engineering Science*. 1996;51: 1347.
9. Liu HS, Lin CC, Wu SC, Hsu HW. Characteristics of a rotating packed bed. *Ind. Eng. Chem. Res*. 1996;35:3590-3596.
10. Reddy KJ, Gupta A, Rao DP, Rama OP. Process intensification in a HiGee with split packing. *Ind. Eng. Chem. Res*. 2006;45: 4270-4277.
11. Chen YS, Lin FY, Lin CC, Tai CYD, Liu HS. Packing characteristics for mass transfer in a rotating packed bed. *Industrial*

- & Engineering Chemistry Research. 2006;45(20):6846-6853.
12. Zhao H, Shao L, Chen JF. High-gravity process intensification technology and application. *Chemical Engineering Journal*. 2010;156:588-593.
 13. Wang GQ, Xu ZC, Ji JB. Progress on HiGee distillation-Introduction to a new device and its industrial applications. *Chemical Engineering Research and Design*. 2011;89:1434-1442.
 14. Wang GQ, Xu OG, Xu ZC, Ji JB. New HiGee-rotating zigzag bed and its mass transfer performance. *Industrial & Engineering Chemistry Research*. 2008; 47(22):8840-8846.
 15. Aoune A, Ramshaw C. Process intensification: Heat and mass transfer characteristics of liquid films on rotating discs. *International Journal of Heat and Mass Transfer*. 1999;42:2543.
 16. Reay D, Ramshaw C, Harvey A. *Process intensification - engineering for efficiency, sustainability and flexibility*, 1st ed., Butterworth-Heinemann, Burlington, MA; 2008.
 17. Burns JR, Jamil JN, Ramshaw C. Process intensification: Operating characteristics of rotating packed beds - determination of liquid hold-up for a high voidage structured packing. *Chemical Engineering Science*. 2000;55:2401-2415.
 18. Kolev N. *Packed bed columns: For absorption, desorption, rectification and direct heat transfer*. Elsevier BV: Oxford, U.K; 2006.
 19. Sherwood KT, Shipley GH, Holloway FAL. Flooding velocities in packed columns. *Ind. Eng. Chem*. 1938;30:768.
 20. Sherwood KT, Holloway FAL. Performance of packed towers – liquid film data for several packings. *Trans AIChE*. 1940;36:39-70.
 21. Bisschops MAT, Van der Wielen LAM, KCAM Luyben. Centrifugal adsorption technology for the removal of volatile organic compounds from water. *Proceedings, 2nd Intl. Conf. Proc. Intensif. in Pract.*, 28, BHR Group, London. 1997; 299–307.
 22. Chia-Chang L, Yu-Shao C, Hwai-Shen L. Prediction of liquid hold up in counter current flow rotating packed bed reactor. *Trans I Chem E*. 2000;78:397-403.
 23. Zhang D, Zhang PY, Zou HK, Chu GW, Wu W, Zhu ZW, Chen JF. Application of HiGee process intensification technology in synthesis of petroleum sulfonate surfactant. *Chemical Engineering and Processing: Process Intensification*. 2010; 49(5):508-513.
 24. Stankiewicz A. Process intensification. *Ind. Eng. Chem. Res*. 2002;41(8):1920-1924.
 25. Agarwal L, Pavani V, Rao DP, Kaistha N. Process intensification in HiGee absorption and distillation: Design procedure and applications. *Industrial Engineering Chemistry Research*. 2010;49:100046-10058.
 26. Christensen DL. Gas dehydration. M.Sc. Eng. Thesis Aalborg University Esbjerg Denmark; 2009.
 27. Stankiewicz AI, Moulijn JA. Process intensification: Transforming chemical engineering. *Chemical Engineering Progress*. 2000;22-34.
 28. Rajan SK. Limiting gas liquid flows and mass transfer in a novel rotating packed bed, M. Tech. Thesis, Department of Chemical Engineering, Indian Institute of Technology, Kanpur, India; 2008.
 29. Jassim MS. Process intensification: Absorption and desorption of carbon dioxide from monoethanolamine solutions using HiGee technology, PhD thesis, Newcastle University; 2002.
 30. Qiu Z, Zhao L, Weatherley L. Process intensification technologies in continuous biodiesel production. *Chemical Engineering and Processing: Process Intensification*. US: Elsevier. 2010;49(4): 323-330.
 31. Kelleher T, Fair JR. Distillation studies in a high-gravity contactor. *Ind. Eng. Chem. Res*. 1996;35:4646-4655.
 32. Nascimento JVS, Ravagnani TMK, Pereira JAFR. Experimental study of a rotating packed bed distillation column. *Brazilian Journal of Chemical Engineering*. 2009; 26(1):219-226.
 33. David Reay (). The role of process intensification in cutting greenhouse gas emissions. *Applied Thermal Engineering*. 2008;28(16):2011-2019. ISSN 1359-4311. Available:<http://dx.doi.org/10.1016/j.applthermaleng.2008.01.004>
Available:<http://www.sciencedirect.com/science/article/pii/S1359431108000197>
 34. Etchells JC. Process Intensification: Safety pros and cons. *Process Safety and Environmental Protection*. 2005;83(2):85-89. ISSN 0957-5820. Available:<http://dx.doi.org/10.1205/psep.04241>

- Available:<http://www.sciencedirect.com/science/article/pii/S0957582005712210>
35. Jacob A. Moulijn, Andrzej Stankiewicz, Johan Grievink, Andrzej Górak. Process intensification and process systems engineering. A friendly symbiosis. Available:<http://dx.doi.org/10.1016/j.compchemeng.2007.05.014>
Available:<http://www.sciencedirect.com/science/article/pii/S0098135407001512>
- Computers & Chemical Engineering, 2008;32(1–2):3-11. ISSN 0098-1354.

© 2015 Ehinmowo et al.; This is an Open Access article distributed under the terms of the Creative Commons Attribution License (<http://creativecommons.org/licenses/by/4.0>), which permits unrestricted use, distribution, and reproduction in any medium, provided the original work is properly cited.

Peer-review history:
The peer review history for this paper can be accessed here:
<http://sciencedomain.org/review-history/10247>