



## Development of a Low-Cost Smart PIG and Wireless Sensor for the Detection of Pipeline Defects and Anomalies

Oluwafemi OLUGBOJI<sup>1</sup>, Mathew ABOLARIN<sup>1</sup>, Oyewole ADEDIPE<sup>1</sup>, Gbenga ATOLAGBE<sup>1</sup>, Adinoyi SADIQ<sup>1</sup>, Odushina AJAYI<sup>1</sup>

<sup>1</sup>Mechanical Engineering Department, Federal University of Technology, Minna, Nigeria

[olubojioluwafemi@futminna.edu.ng](mailto:olubojioluwafemi@futminna.edu.ng)/[msabolarin2006@gmail.com](mailto:msabolarin2006@gmail.com)/[adelordy2002@yahoo.com](mailto:adelordy2002@yahoo.com)/[gbenga.abayomi247@gmail.com](mailto:gbenga.abayomi247@gmail.com)/[sadiqadinoyi@gmail.com](mailto:sadiqadinoyi@gmail.com)

Corresponding Author: [gbenga.abayomi247@gmail.com](mailto:gbenga.abayomi247@gmail.com)

Date Submitted: 11/11/2019

Date Accepted: 15/03/2020

Date Published: 30/06/2020

**Abstract:** Inspecting the inside or outside circumstances of a buried pipeline is very difficult, as visual inspection is overwhelming and costly; also, the procurement cost of most conventional Pipeline Inspection Gauges (PIGs) are usually overbearing; and they usually come in huge sizes, making it too heavy to install. This study aimed at developing a low-cost smart PIG for defects (leakage) detection in pipelines. The smart PIG was developed using locally sourced materials and off-the-shelf sensors and electronics to provide a low-cost alternative to traditional Intelligent PIGs. The major components used in the design includes: SparkFun Pressure Sensor Breakout: MS5803-14BA, Motion Sensor (SparkFun 9DoF IMU Breakout: LSM9DSI), the wireless communicator (ESP-01S ESP8266 WiFi module) and Arduino Microcontroller. A no-load test was carried out on the pig by conveying inside a 160mm diameter pipeline of length 6.7m using a 0.125hp D.C motor and a gearbox attachment to pull from end to end. Data were retrieved using a WiFi module and PuTTY software. Pressure irregularities (spikes) were observed at the points of obstruction, based on the pressure values plotted. The higher-pressure pulses (spikes) which were observed at the points of defects created along the pipeline was an indication that the Smart PIG was capable of detecting the created defects. This was an indication that the low-cost smart pig was capable of detecting leakages and can serve as a suitable alternative for the traditional In-line Inspection tools.

**Keywords:** Defects; Inspection; Low-cost; Pipeline Inspection Gauge (PIG); Pipeline; Wireless Sensor

### 1. INTRODUCTION

Predicting the interior or exterior conditions of a buried pipeline poses a very great challenge, as visual inspection is costly and time consuming. Since being introduced sometime in the mid to late 1800s, pipelines have been recognized as being the best method of transporting large quantities of oil, refined petroleum products and natural gas over land [3]. Pipelines are considered the arteries of the oil and gas transportation sector; and any fault in the pipeline would cause huge loss of energy and financial resources [5]. There is also a chance of explosion due to leakages because they convey highly inflammable gases and liquid.

Since pipelines are key components of the oil and gas supply system, their maintenance is therefore vital. The use of Pipeline Inspection Gauge (PIG) as a maintenance technique has been successfully adopted in situations such as cleaning, product separation and inspection of pipes integrity [4]. Damages in pipelines can be accessed only by Pipeline Inspection Gauges (PIGs) because observing the internal surface of the pipeline by any other means usually proves difficult [6]. PIGs are devices which are inserted into a pipeline and travels through it for inspection. Usually, some instruments such as magnetic flux leakage (MFL) sensors are attached to a smart PIG to detect surface damages of the pipeline and their positions [6].

Traditional inspection tools (Intelligent PIGs) are expensive, and charges a high premium rate. An intelligent pigging survey would cost around hundreds of thousands of dollars, with certain long distance, more complicated lines being charged well in excess of this, leading to infrequent cleaning and inspection operations. This results in poor maintenance and pipeline degradation [8].

#### 1.1 Justification of the Research

This study provides a cheaper and better way of developing a smart PIG that would be capable of inspecting and detecting leakages along pipelines conveying water and petroleum products, with the aid of some specialized sensors.

#### 1.2 Aim and Objectives

The study aimed at developing a smart pipeline inspection gauge for defects (leakage) detection in pipelines.

The objectives were:

- (1) to develop low cost smart PIG capable of inspecting pipelines for leakages and obstructions and;
- (2) to provide a means of quick data access and recovery from the smart PIG for analysis purpose.

### 1.3 Background Study

Regulations on pipelines are strict; however, quite a number of pipelines still corrode and leak due to various causes like environmental misuse, external damage, inbuilt manufacturing defects or installation defects, instability and motion in the soil, and third party damage. Since most pipelines are buried somewhat between two to five feet beneath the surface, digging them out and inspecting visually is hard, costly and time-consuming [3].

### 1.4 Leak Detection Methods

Leak detection methods are measures that are put in place to stop or checkmate events that would otherwise lead to run off of oil from a pipeline. The methods and techniques for the detection of hydrocarbon leaks from pipelines as used by the oil and gas industry are reviewed and can be categorized into nine main classes based on the principle of operation [1]. The nine main classes of pipeline leak detection are described in *Table 1*.

Table 1: Classes of leak detection methods.

S/N	Methods of Detection	Examples of tools that employs the method
1	Laser Scanning	Laser scanning, Buckle detectors, etc.
2	Ultrasonic	Intelligent pigging, Automatic ultrasonic tester, TOFD, Ultrasonic probe testers etc.
3	Acoustic	Acoustic Leak detector, hydrophones, Electromagnetic Acoustic Transducers (EMAT), piezoelectric meter etc.
4	Fibre Optics	Optical sensors (for leak, strain, fatigue and ground movement detection), etc
5	Visual Inspection	Use of human eye, Inspection light, Robotic crawlers etc.
6	Magnetic flux leakage method	Intelligent pigging, Eddy current, Magnetic particle inspection etc.
7	Inventory accounting (pressure differentials, mass flow-rates etc)	Negative pressure wave detectors
8	Fluorometry/ Hydrocarbon Leak detection sensors	Fluorescence detectors, Hydro-chemical detectors.
9	Temperature based sensors	Thermal spray technology etc.

(Source: [1].)

## 2. METHODOLOGY

### 2.1 Design Consideration

Just as it is necessary to put many parameters into consideration in the design of any machine, pigging operation also requires the consideration of some parameters. Some of the parameters involved in pigging operation are velocity; maximum and minimum operating temperature and pressure; the interaction of the PIG with the pipe wall; compactness of the electronics and sensors to fit into the PIG; types of sensors and their positioning within the PIG; availability of the components; determination of optimum speed of the PIG; design of PIG capable of performing optimally in the desired diameters; the effects of by-pass and optimum by-pass configuration; the effects of the differential pressures across the seals [10].

However, most of the available knowledge is based on field experience. Hence selecting the best PIG often involves some trial and error, and consequently a high degree of uncertainty [9]. In this study, the Smart PIG design was based on the pipeline fitting, which is the ability of the PIG to perform optimally in a range of diameter.

### 2.2 Design Goals of the Smart PIG

It is important to point out that the primary design goal to be met by the Smart PIG is the reduction in cost of smart pigging, through a simplified design of the PIG using locally sourced materials. It is also desired to keep the design simple and standardized, in order to avoid the use of expensive sensors, regulators and locally built parts were used as much as possible. The electronic circuit was designed to accommodate the sensors, allow for easy reception and transmission of data via the provided WiFi module to the user's laptop.

The test bed was designed to apply the necessary pressure required to propel the PIG through the pipe. This was done with the aim of keeping the design economically viable for extensive use in the petroleum industry.



Figure 1: A Typical Ultrasonic Tool. (Source: <http://aras.kntu.ac.ir>)

### 2.3 Smart PIG Test Procedures Analysis

The necessary summaries of the initial test bed procedure and design are explained in this section.

#### 1) Test Equipment:

The major test apparatus for the Smart PIG includes:

- Test leads;
- DC motor and gearbox unit (for no load test);
- Strings (for no load test);
- Laptop with installed PuTTY software; and
- Test Rig

#### 2) Test Rig Set-Up:

Equipment used as labelled respectively in Figure 2, for the construction of the rig are:

- (1) Mild steel Support;
- (2) 160mm diameter pipe;
- (3) End attachment;
- (4) PIG assembly; and
- (5) Pulling Mechanism

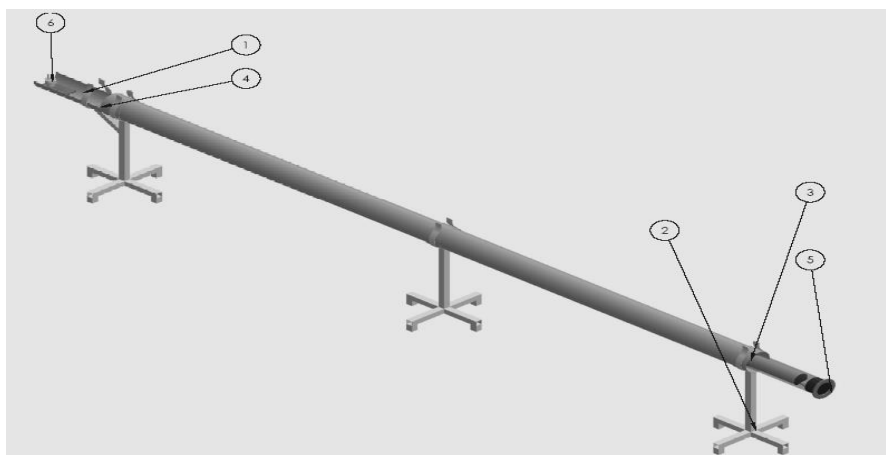

Figure 2: Set-up of the No-Load Test Rig

### 3) Visual Inspection:

The reason for carrying out visual inspection was to check against any early non-conformity with build instructions. The following highlights are the inspection areas:

- Damage to components;
- Damage to PCB tracks;
- Short circuit or solder bridges;
- Damaged or unclean connector;
- Loose connections

### 4) No Load Test:

The purpose of the test was to test the smart PIG with no liquid in the pipeline and to mechanically drive the PIG using a pulling mechanism to propel it over a certain distance.

## 2.4 Design Analysis of Electronics

The electronic components used were selected based on the design considerations. The following are the features and description of some of the vital components used in the electronic module.

### SparkFun Pressure Sensor Breakout: MS5803-14BA:

This is a new generation miniature pressure sensor module that operates within the range of 0 to 14 bars with high resolution of 0.2 mbar. The smart PIG was built with two of these sensors (shown in Figure 3) to measure the front and rear pressures. The MS5803-14BA can be interfaced to any microcontroller.

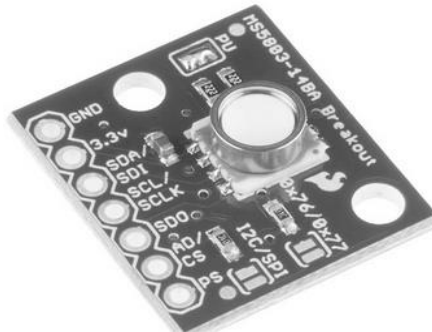

Figure 3: SparkFun Pressure Sensor-MS5803-14BA Breakout. (Source: [www.sparkfun.com](http://www.sparkfun.com))

### Wireless Communication:

The wireless communicator was used to transmit data from the smart PIG sensors to a collection point for analysis. The wireless communicator used in this study was ESP-01S ESP8266 WiFi module, shown in figure 4. The module is a self contained SOC with integrated TCP/IP protocol stack that can give any microcontroller access to personalized WiFi network. Each ESP8266 module comes pre-programmed with an AT command set firmware. This means that it can be hooked to an Arduino device and get about as much WiFi ability as a WiFi shield offers.



Figure 4: ESP-01S ESP8266 WiFi module. (Source: [www.4tronix.co.uk](http://www.4tronix.co.uk))

## The Constructed Smart PIG

The smart pig construction was carried out using the materials listed as follows. Most of the materials were sourced locally. The components labelled respectively in figure 5 are:

1. PIG casing;
2. PIG cap;
3. Electronics compartment;

4. Flow pipe;
5. Electronics compartment cap;
6. Battery; and
7. Electronics circuit

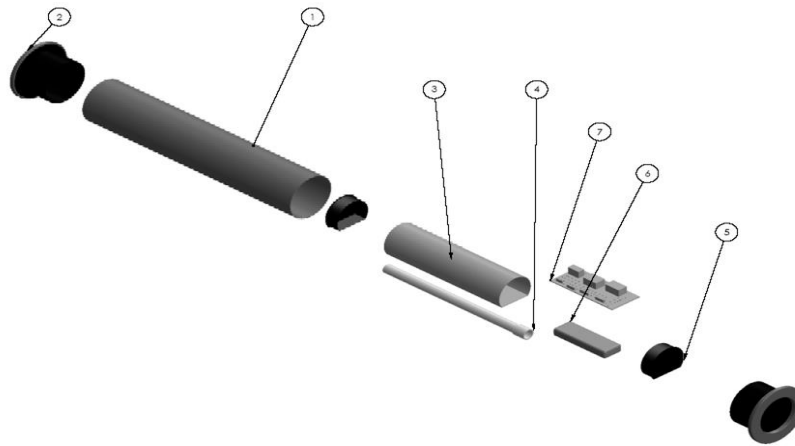

Figure 5: Exploded View of the Constructed Smart PIG

### 3.0 RESULTS AND DISCUSSION

#### 3.1 Test Results

The no load test was carried out on the test bed constructed as shown in Figure.2. Defects were created at three points on the pipeline; and obstructions were placed at these points. This was done to simulate a real life defects that occurs in pipeline.

Series of tests were carried out on the PIG. The tests carried out were:

- Stationary test: this was done by placing the PIG stationary at a point at room temperature;
- No-load No defect test: this refers to the no load test carried out when no defects was present in the pipeline;
- No-load Defect test: this was the test carried out when a defect was induced on the pipeline

#### Stationary Test Result and Discussion:

The smart PIG was allowed to run for five minutes at room temperature and still air as data (pressure readings) were transferred to the laptop via the Wifi and the PuTTY software. The results of values P1 (pressure at the front of the PIG) and P2 (pressure at the back of the PIG) obtained from the stationary test was plotted using Microsoft Excel as shown in Figure 6 and Figure 7.

The spikes seen on the graph are called pressure pulses. It implies that the pressure measured cannot remain constant because of external influences such as: noise, external vibration, changes in altitude etc. Values of P1 were observed to be greater than that of P2. The reason for this was that the two sensors was not accurately position on the same level. Therefore, the values obtainable from P1 will always be greater than P2.

The P1 values ranges from 1213Pa to 1214Pa, the average being 1213.86Pa. The P2 values ranges from 1094Pa to 1094.75Pa, with an average value of 1094.24Pa.

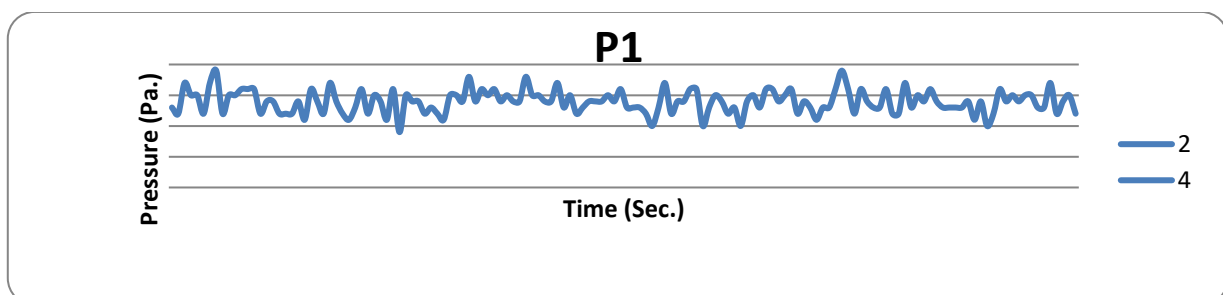

Figure 6: Graph of Pressure, P1 against Time for Stationary Test1

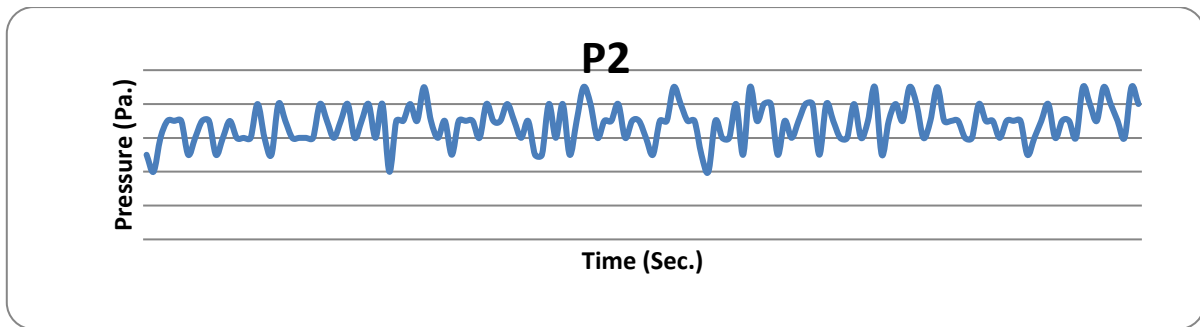

Figure 7: Graph of Pressure, P2 against Time for Stationary Test1

**No-load No Defect Result and Discussion:**

After the PIG has been inspected by eye and confirmed okay by the stationary test, it was further tested by traversing pipeline a 160mm diameter pipeline of 6.7m length. The results obtained from this test are presented in Figure 8 and Figure 9. The trend observed in Figure 8 and Figure 9 is different from that of the stationary test graph. The pressure P1 began at 1221.8Pa. This is relatively higher than that of the P1 for the stationary test. The reason for this was because the rear side of the test rig was more elevated than the front side; and because of the unlevelled ground where the test was conducted. So, the pressure started at the 1221.8 Pa and dropped gradually for the first one minute until it got to an average value of about 1214Pa where it remained constant till the end of the experiment.

Similarly, for the graph of pressure P2, Figure 9, the pressure began to drop from an average value of 1094Pa. during the last one minute of the experiment. The reason for this was the reverse of what happened with pressure P2. In this case, the front end of the test rig was slightly depressed, this made the value to drop below the average of 1094Pa.

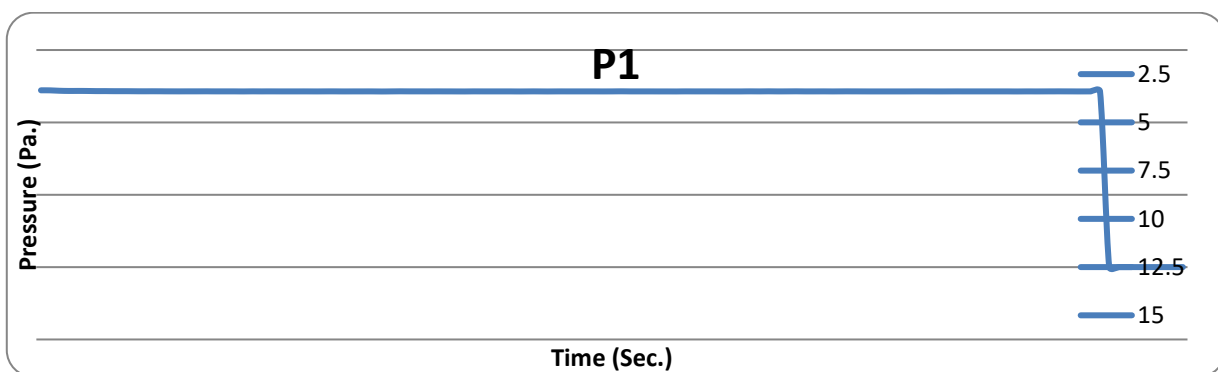

Figure 8: Graph of Pressure, P1 against Time for No load Non-Defected Pipes

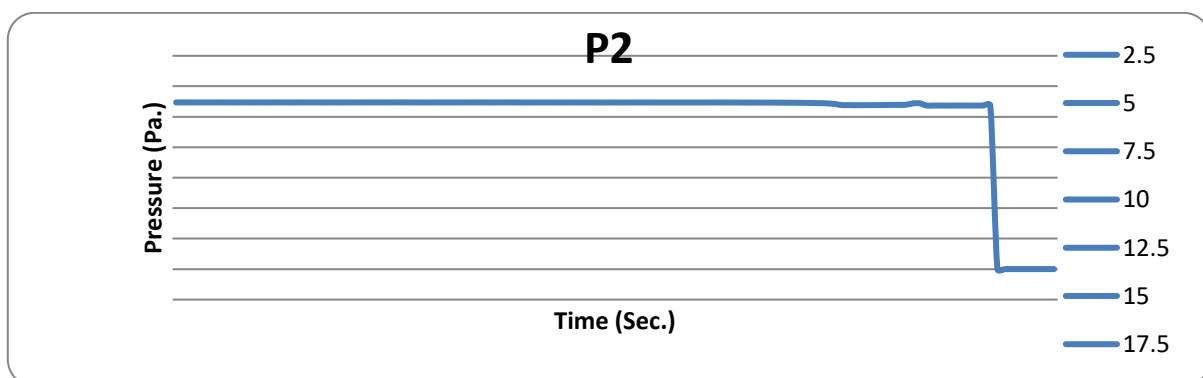

Figure 9: Graph of Pressure, P2 against Time for No load Non-Defected Pipes

**No-load Defect Result and Discussion:**

Again, a no-load test was carried out by traversing the PIG in the defected pipeline. It took approximately six (6) minutes for the PIG to travel through the entire length of the pipeline. The results are presented in Figures 10 and 11 for P1 and P2 respectively.

Figures 10 and 11 shows trend that are different from that of the stationary and the no defect test. This was because of the presence of the defect in the pipeline. Sharp spikes as shown in Figure 10 and 11 are the points of these defects. The pressure

P1 again began at 1226.8Pa. This is relatively higher than that of the P1 for the stationary test. The reason for this was also because the rear side of the test rig was more elevated than the front side; and because of the rough terrain where the test rig was placed. So, the pressure started at the 1226.8Pa and dropped gradually for the first 1.5min and then remained at an average of 1214.2Pa for the next 20sec. until it got to the first defected point where a value of 1216.1Pa was observed. The PIG continued to traverse the pipeline until all the pressure pulses at the defected points were captured. The values obtained at this point were 1216Pa and 1217.5Pa for the second and third defected points respectively.

Similarly, for the graph of pressure P2 for the no load defect test, Figure 11; the pressure again began to drop from an average value of 1094.2Pa. during the last one minute of the experiment. The reason for this was the reverse of what happened with pressure P2. In this case, the front end of the test rig was slightly depressed; this made the value to drop below the average of 1094.2Pa. The sensor also captured values of 1095.2Pa, 1095.3Pa and 1095.4Pa for the first, second and third defected points respectively.

All these evidence proved that the PIG performed as expected since the trend observed from the graphs showed pressured pulses that were similar to that of [7] and [2].

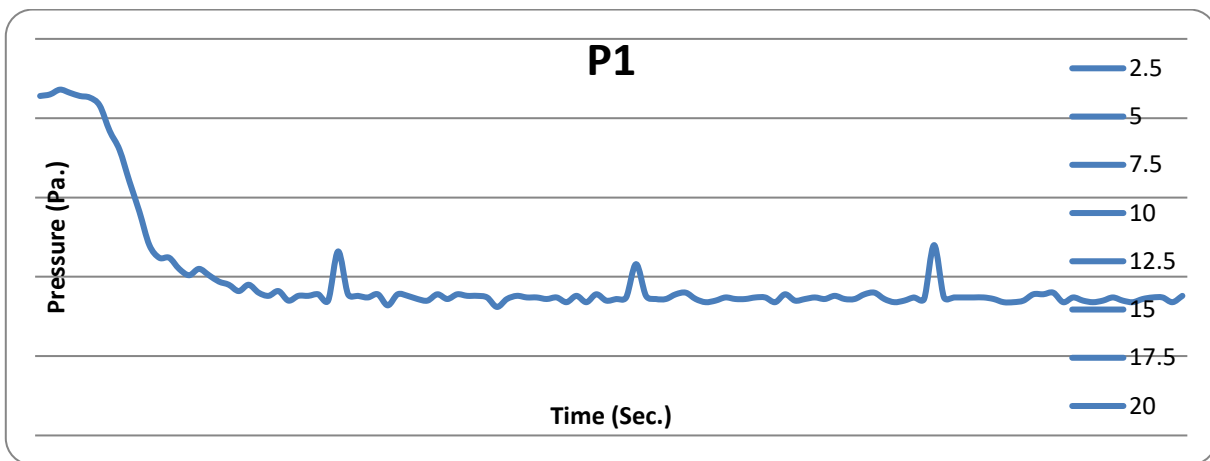

Figure 10: Graph of Pressure, P1 against Time for No load Defected Pipes

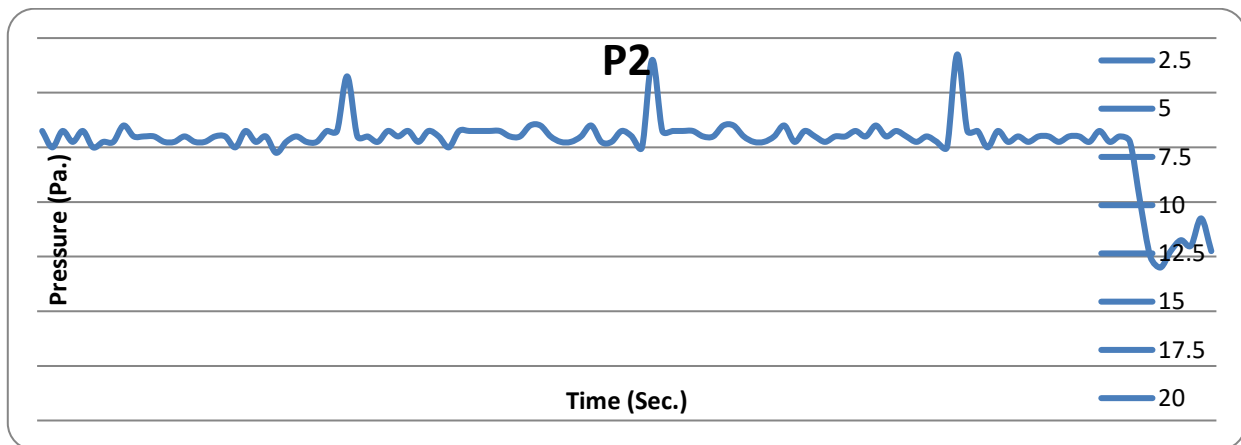

Figure 11: Graph of Pressure, P2 against Time for No load Defected Pipes

#### 4. CONCLUSION

The smart pig was constructed and tested; and proved to be capable of detecting defects along the pipeline by transmitting data (pressure readings) via a WiFi module. It was developed as a low-cost alternative to traditional Intelligent PIGs using locally sourced materials and off the shelf sensors and electronics. The Smart PIG has been designed with the capability of carrying the pressure sensors as an intricate component of the PIG as compared to those reviewed using pressure transducer monitoring technique, in which the sensors were only attached to points along the pipelines. The PIG is still in the developmental stage as test using flowing fluids are still ongoing.

#### REFERENCES

- [1] Agbakwuru, J. (2011). Pipeline Potential Leak Detection Technologies : Assessment and Perspective in the Nigeria Niger Delta Region. *Journal of Environmental Protection*, 2, 1055–1061. <https://doi.org/10.4236/jep.2011.28121>.
- [2] Araújo, R. P. De, Carvalho, V., Freitas, G. De, Lima, G. F. De, Salazar, A. O., Adriaio, D. D. N., & Maitelli, A. L. (2018). Pipeline Inspection Gauge ' s Velocity Simulation Based on Pressure Differential Using Artificial Neural Networks. *Sensors*, 2(9), 1–15. <https://doi.org/10.3390/s18093072>.
- [3] Brownman, C. (2005). Hazardous Liquids Pipelines – Regulation and Due Diligence. *Journal of Pipeline Engineering*, 2, 1–7.
- [4] Freitas, V. C. G., Lima, G. F., Salazar, A. O., & Maitelli, A. L. (2016). “ PIG ” Detection with Pressure Transducers. *International Journal of Advanced Research in Electrical, Electronics and Instrumentation Engineering*, 5(9), 7497–7503. <https://doi.org/10.15662/IJAREEIE.2016.0509051>.
- [5] Kumar, M., & Sorabh. (2013). Inspection of Pipelines Using MFL Technique. *Journal of Pipeline Engineering*, 2(6), 13–17.
- [6] Lesani, M., Rafeeyan, M., & Sohankar, A. (2012). Dimensional Liquid Pipeline. *Journal of Applied Fluid Mechanics*, 5(2), 75–83.
- [7] Lima, G., Freitas, V., Araujo, R., Maitelli, A., & Salazar, A. (2017). PIG ' s Speed Estimated with Pressure Transducers and Hall Effect Sensor : An Industrial Application of Sensors to Validate a Testing Laboratory. *Sensors*, 1(7), 1–12. <https://doi.org/10.3390/s17092119>.
- [8] Olugboji, O. A., Sadiq, A. A., Olorunsaiye, O., Peters, D. O., & Ajayi, B. A. (2015). DEVELOPMENT OF A SMART PIPE INSPECTION GAUGE FOR DETECTION OF PIPELINE DEFECTS. In *ASME 2015 International Mechanical Engineering Congress and Exposition* (pp. 1–10). Texas.
- [9] Ong, J. K., Kerr, D., & Bouazza-Marouf, K. (2003). Design of a semi-autonomous modular robotic vehicle for gas pipeline inspection. *Journal of Systems and Control Engineering*, 217(2), 109–122.
- [10] Schempf, H., Mutschler, E., Gavaert, A., Skoptsov, G., & Crowley, W. (2010). Visual and Nondestructive Evaluation Inspection of Live Gas Mains Using the Explorer Family of Pipe Robots. *Journal of Field Robotics*, 33, 1–33. <https://doi.org/10.1002/rob>.