



Whale optimization algorithm: a systematic review of contemporary applications, modifications and developments

Nadim Rana^{1,2} · Muhammad Shafie Abd Latiff¹ · Shafi'i Muhammad Abdulhamid³ · Haruna Chiroma⁴

Received: 5 July 2018 / Accepted: 14 March 2020 / Published online: 30 March 2020
© Springer-Verlag London Ltd., part of Springer Nature 2020

Abstract

Whale optimization algorithm (WOA) is a recently developed swarm-based meta-heuristic algorithm that is based on the bubble-net hunting maneuver technique—of humpback whales—for solving the complex optimization problems. It has been widely accepted swarm intelligence technique in various engineering fields due to its simple structure, less required operator, fast convergence speed and better balancing capability between exploration and exploitation phases. Owing to its optimal performance and efficiency, the applications of the algorithm have extensively been utilized in multidisciplinary fields in the recent past. This paper investigates further into WOA of its applications, modifications, and hybridizations across various fields of engineering. The description of the strengths, weaknesses and opportunities to support future research are also explored. The Systematic Literature Review is opted as a method to disseminate the findings and gap from the existing literature. The authors select eighty-two (82) articles as a primary studies out of nine hundred and thirty-nine (939) articles between 2016 and 2020. As per our result, WOA-based techniques are applied in 5 fields and 17 subfields of various engineering domains. 61% work has been found on modification, 27% on hybridization and 12% on multi-objective variants of WOA techniques. The growing research trend on WOA is expected to continue into the future. The review presented in the paper has the potential to motivate expert researchers to propose more novel WOA-based algorithms, and it can serve as an initial reading material for a novice researcher.

Keywords Whale optimization algorithm · Meta-heuristic · Swarm based · Bubble-net hunting

Electronic supplementary material The online version of this article (<https://doi.org/10.1007/s00521-020-04849-z>) contains supplementary material, which is available to authorized users.

✉ Nadim Rana
nadimrana17@gmail.com; nadimrana@jazanu.edu.sa

Muhammad Shafie Abd Latiff
shafie@utm.my

Shafi'i Muhammad Abdulhamid
shafii.abdulhamid@futminna.edu.ng

Haruna Chiroma
freedonchi@yahoo.com

- ¹ Faculty of Computing, Universiti Teknologi Malaysia, 81310 Skudai, Johor, Malaysia
- ² College of Computer Science and Information Technology, Jazan University, Jazan, Kingdom of Saudi Arabia
- ³ Department of Cyber Security Science, Federal University of Technology, Minna, Niger State, Nigeria
- ⁴ Future Technology Research Center, National Yunlin University of Science and Technology, Yunlin, Taiwan

1 Introduction

Nature-inspired meta-heuristic algorithms belong to the realm of computational intelligence (CI). Biology-based CI (BbCI), Physics-based CI (PbCI), Chemistry-based CI (CbCI), and Mathematics-based CI (MbCI) are the four broad categories of the algorithms of computational intelligence [101]. Biology-based meta-heuristic algorithms can be further classified into two major classes, namely evaluation-based and swarm-based algorithms (Fig. 1). Swarm-based meta-heuristic algorithms have been widely accepted optimization methods in several engineering fields due to the fact that it has advantage over other classes of nature-inspired algorithms. It offers an edge over evaluation-based algorithm by preserving the search space information after each subsequent iteration and fewer operators for successful execution. On the other hand, the evaluation-based algorithms cannot retain the information as soon as the new population is generated and it requires more operators [65]. Accordingly, swarm-based algorithm has been proven to be

Fig. 1 Classification of meta-heuristic algorithms

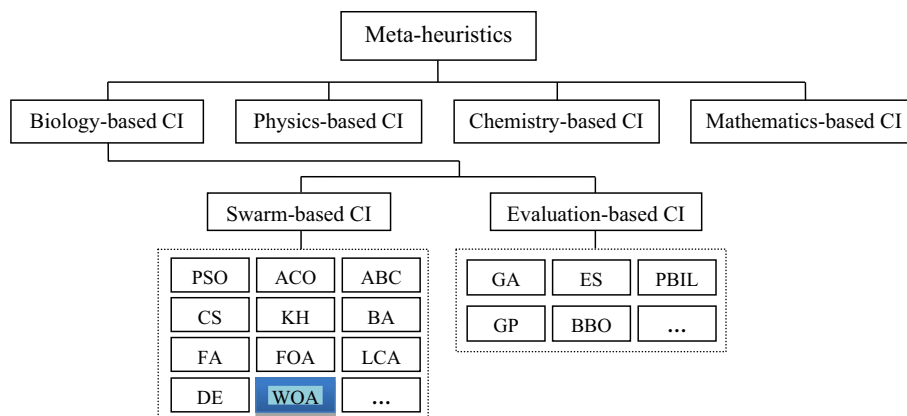

more efficient in solving high-dimensional combinatorial and nonlinear optimization problems in a large space search domain with an exponential growth in the problem size [11, 35, 90]. Meta-heuristic algorithms have always been the topic of attraction among the research community for almost two decades. Some of the widely accepted and well-studied swarm-based algorithms found in the literatures are: particle swarm optimization (PSO) [50, 86], ant colony optimization (ACO) [26, 27], artificial bee colony (ABC) [45], cuckoo search (CS) algorithm [19, 105], krill herd (KH) algorithm [88], Bat-Inspired (BA) algorithm [104], firefly algorithm (FA) [106], fruit fly optimization algorithm (FOA) [72], league championship algorithm (LCA) [3, 46], bird mating optimizer (BMO) [10], and dolphin echolocation (DE) [48], etc. Similarly, the other generation of evaluation-based algorithms, which are widely accepted and studied are: genetic algorithm (GA) [22, 114], evolution strategy (ES) [52], probability-based incremental learning (PBIL) [21], genetic programming (GP) [51, 53], and biogeography-based optimizer (BBO) [14, 92], to name a few.

This study presents a systematic review on the recently developed swarm-based meta-heuristic optimization algorithm (namely, whale optimization algorithm, WOA), which is based on the maneuver of the hunting of humpback whales (*Megaptera novaeangliae*). To the knowledge of the authors, no comprehensive literature review is available on the novel WOA.

The recent literature shows that WOA has a tremendous capability of solving complex engineering optimization problems [116]. It's evident advantages such as, simplicity, flexibility, fast convergence speed, and stochastic nature gained outstanding attention among the current research community in multiple disciplines, such as electrical and power systems, data mining and machine learning, wireless sensor network (WSN), network optimization, robotics path planning, training artificial neural networks (ANN), cloud computing and IoT, applied mathematics, aero-engine optimization, and skeletal structure design. Some of

the striking features of the WOA are its balanced implementation of the exploration (global search) and exploitation (local search) strategies of searching, and its successful execution even with a lesser number of parameter [20, 57, 58]. Moreover, it can also inherit the efficient function of evaluation-based algorithm combining crossover and mutation process within its structure. Resultantly, it builds a very strong framework exploiting better convergence rate. Unlike other meta-heuristic algorithms, WOA tends to have some drawbacks. As per the existing literature, the power of basic WOA lies in its global exploration phase, but sometimes it may get trapped into local optima and fails to apply the global search exhaustively [116]. These limitations encourage the researchers to modify and hybridize it with other methods or meta-heuristics for solving high-dimensional problems. Though, the inception and development of the WOA is very recent and its implementation lies in initial phase, a rapid growth is witnessed in the applications of WOA in multidisciplinary optimization problem solutions (Figs. 12 and 13). Hence, it can be safely anticipated that the applications of WOA in theory and practice are bound to expand beyond expectations.

The goal of the study is to disseminate a comprehensive summary of the related research works on the application of WOA in the various fields of engineering to solve complex optimization problems. Furthermore, the review also presents the outcomes of the study in terms of challenges and opportunities for future researchers. This review is classified into four sections: (1) application of WOA in various engineering domains, (2) modification-based applications, (3) hybridization-based applications, (4) multi-objective applications of WOA in different fields. The classification of the literature is based on the applicability of the WOA in different fields and subfields of engineering, rather than the modifications, hybridizations, and parameter enhancements of the algorithm (see woa.xlsx). However, the modifications, hybridizations, and enhancements are inherently present in each classification.

The objective of the classification is to discover and highlight the pattern of development of WOA as shown in Fig. 1.

The paper seeks to answer the following questions:

- (1) What are the modifications made on the WOA?
- (2) What are the hybridizations made with the WOA and feature of other algorithms?
- (3) What are the multi-objective applications of the WOA in different fields?
- (4) What are the applications of the WOA in different engineering domains?

The organization of this paper is as follows. A general description of the structure of WOA is provided in Sect. 2. The research methodology for this review is discussed in Sect. 3. The review of the WOA on account of its modifications, hybridizations and application is delineated in Sect. 4, whereas open problems and future direction are discussed in Sect. 5. Finally, conclusion and discussion are put forth in Sect. 6.

2 General structure of WO algorithm

WOA is a swarm-based intelligent algorithm proposed for continuous optimization problems. It has been proven to exhibit superior performance with recent meta-heuristics methods [65]. For instance, when compared with other swarm intelligence methods, it is easy to implement and robust which makes it comparable to different nature-inspired algorithms. The algorithm requires fewer control parameters; practically, only a single parameter (time interval) needs to be fine-tuned. In WOA, the population of humpback whales search through a multi-dimensional search space for food as shown in Fig. 2. The locations of humpback individuals are represented as different decision

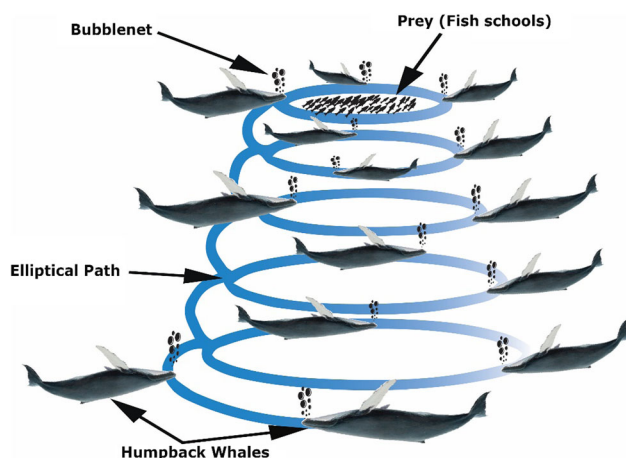

Fig. 2 Bubble-net feeding behavior of humpback whales

variables, while the distance between the humpback whale individuals and the food corresponds to the value of objective cost. Note that the time-dependent location of a whale individual is measured by three operational processes: (1) shrinking encircling prey, (2) bubble-net attacking method (exploitation phase) and (3) search for prey (exploration phase). Figure 3 shows the basic presentation of the WOA. The description and the mathematical expression of these operational processes are provided in the following subsections.

2.1 Encircling prey

Humpback whales can recognize the location of prey and encircle them. Since the position of the optimal design in the search space is not known a priori, the WOA assumes that the current best candidate solution is the target prey or is close to the optimum. The effort is made to identify the best search agent, while the other search agents will update their positions near to the best search agent. The behavior is expressed by the following equations as stated by [65]:

$$\vec{D} = \left| \vec{C} \cdot \vec{X}^*(t) - \vec{X}(t) \right| \tag{1}$$

$$\vec{X}(t+1) = \vec{X}^*(t) - \vec{A} \cdot \vec{D} \tag{2}$$

$$\vec{A} = 2\vec{a} \cdot \vec{r} - \vec{a} \tag{3}$$

$$\vec{C} = 2 \cdot \vec{r} \tag{4}$$

where \vec{X}^* is the general best position, \vec{X} represents whale position, t specifies the recent iteration, a represents linearly reduced within the range of 2 to 0 over the course of iterations, and r is a random number uniformly distributed in the range of [0, 1]. The sign “|” represents the absolute value.

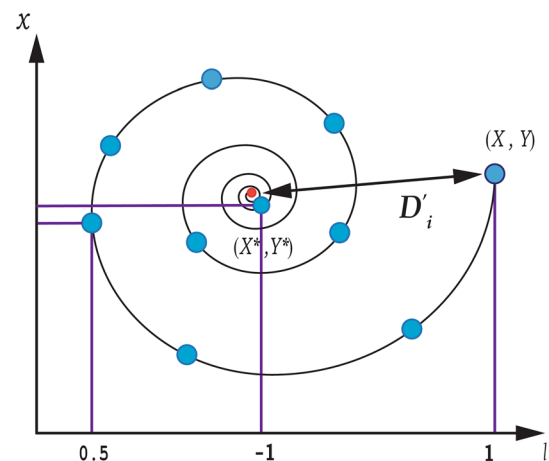

Fig. 3 Spiral updating position

2.2 Bubble-net attacking method (exploitation phase)

To formulate the bubble-net behavior of humpback whale, a spiral mathematical formulation is applied between the position of whale and prey to imitate the helix-shaped movement of humpback whales as shown in Fig. 4 [48]:

$$\vec{X}(t+1) = \vec{D} \cdot e^{bl} \cdot \cos(2\pi l) + \vec{X}^*(t) \tag{5}$$

$$\vec{X}(t+1) = \begin{cases} \vec{X}^*(t) - \vec{A} \cdot \vec{D} & \text{if } p < 0.5 \\ \vec{D} \cdot e^{bl} \cdot \cos(2\pi l) + \vec{X}^*(t) & \text{if } p \geq 0.5 \end{cases} \tag{6}$$

where p represents a constant for explaining the shape of the logarithmic spiral and k is an arbitrary number uniformly distributed in the range of $[-1, 1]$.

2.3 Search for prey (exploration phase)

To have global optimizers, if $A > 1$ or $A < -1$, the search agent is updated as stated by a randomly chosen search agent in the place of the best search agent (Fig. 5):

$$\vec{D} = \left| \vec{C} \cdot \vec{X}_{rand} - \vec{X} \right| \tag{7}$$

$$\vec{X}(t+1) = \vec{X}_{rand} - \vec{X} \cdot \vec{D} \tag{8}$$

where \vec{X}_{rand} is nominated arbitrarily from whales in the current iteration. For further details, the reader may refer to [65] (Fig. 6).

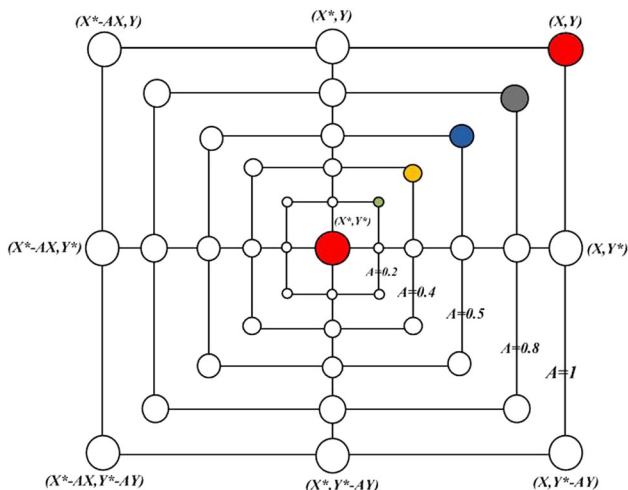

Fig. 4 Bubble-net search mechanism (X^* is the best solution obtained so far)

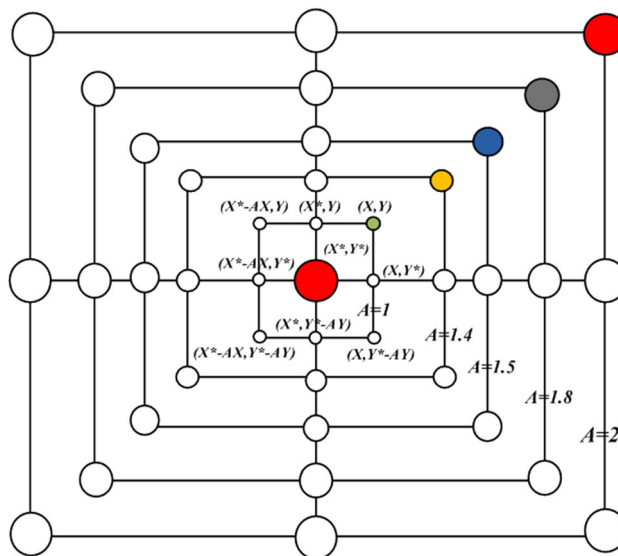

Fig. 5 Exploration mechanism (X^* is a randomly chosen agent)

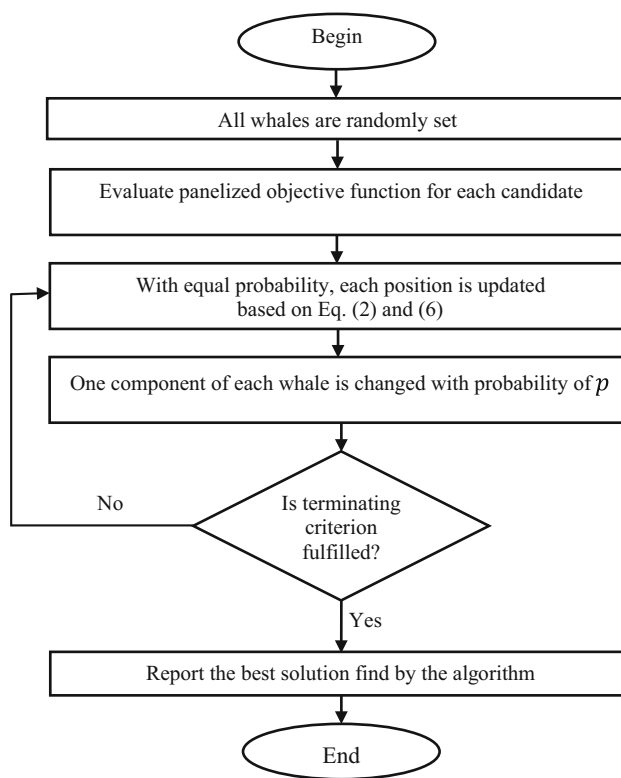

Fig. 6 Flowchart of the WOA [65]

Pseudo-code of Whale Optimization Algorithm (WOA)

```

1. Initialize the whales population  $X_i (i = 1, 2, 3, \dots n)$ 
2. Calculate the fitness of each search agent
3.  $X^*$  = the best search agent
4. while ( $t < maximum\_iteration$ )
5.     for each search agent
6.         Update a, A, C, l, and p
7.         if1 ( $p < 0.5$ )
8.             if2 ( $|A| < 1$ )
9.                 Update the position of the current search agent by Eq. (2)
10.            else if2 ( $|A| \geq 1$ )
11.                Select a random search agent ( $X_{rand}$ )
12.                Update the position of the current search agent by Eq. (8)
13.            end if2
14.        else if1 ( $p \geq 0.5$ )
15.            Update the position of the current search by Eq. (5)
16.        end if1
17.    end for
18.    Check if any search agent goes beyond the search space and amend it
19.    Calculate the fitness of each search agent
20.    Update  $X^*$  if there is a better solution
21.     $t = t + 1$ 
22. end while
23. return  $X^*$ 

```

3 Research methodology

A comprehensive research methodology has been adopted to explore the articles based on WOA and published in popular scientific databases. The articles were chosen through a regressive filtering process with a defined set of criteria, which traverse through four stages shown in Fig. 10. Finally, relevant articles are finalized based on exclusion and inclusion criteria for the review purpose.

3.1 Keywords-based articles search

The keyword search process was done in two steps. In the first step, maximum numbers of documents were retrieved from the most relevant databases using the following keywords: “Whale Optimization Algorithm*”, “WOA*”, “Bubble-net search*”, “Shrinking encircling prey*”, “modified WOA*”, “enhanced WOA*”, “hybrid WOA”, etc. In the second stride, a document filtering process was executed to exclude irrelevant documents. Details of the filtering process can be seen in Sects. 3.4 and 3.5 “selection criteria” and “extraction of data,” respectively.

In our first search—conducted between 24th July and 24th August in the year of 2017—we found only 37 relevant articles matching to our criteria. To include the latest published articles in our research, we held our second search in February 2019 and third and final search in

December 2019. The second and final search consequently returned 32 and 13 more articles and ended up with 82 articles in total to include in this survey. However, it is worth mentioning that we discarded the articles that written in languages other than English, short papers, articles in the press, book chapters, and substandard articles for this review.

3.2 Search strategies

The search strategy based on the guideline in [59] was applied to almost all the domains, where WOA is implemented. The articles were searched on all the available authentic online databases, and then a rigorous process of verification of references and citations in the documents ensured the selection of only high standard peer-reviewed articles. Moreover, the presence of the articles in the disciplines other than engineering and computer science was also taken into consideration for this study.

3.3 Research database selection

The review considers most of the authentic publisher’s databases available online such as: ACM, ISI Web of Sciences, Scopus, ScienceDirect, Emerald, IEEE Explorer, Springer Link, Taylor & Francis, and Google Scholar. Table 1 maintains the number of documents returned from

the above mentioned databases. To provide a tangible proof of the rapid growth of research on WOA, Fig. 7 contains the number of articles published each year by the relevant publishers. Figure 8 supports the same with a graphical representation of the number of articles, publisher-wise. Figure 9 augments the proof by exhibiting publisher-wise percentage of the relevant articles. The time of this writing being the first quarter of the year 2018 and the last quarter of 2019, the number of published articles remains less in 2018 than the years 2017 and 2019, as shown in Fig. 7. It is, however, anticipated that the number will increase considerably during the year 2020.

3.4 Paper selection criteria

Paper selection criteria were set to include the most relevant papers and discard the irrelevant ones. A meticulous method of screening was followed to sort the relevant articles matching the objectives of this study. Then a careful reading scrutiny was performed on titles, abstracts and conclusions to mark the selected articles for further processing. In addition, the filtered articles were thoroughly reviewed by three independent researchers to verify the appropriateness of the articles to the objectives of this study. Finally, the most relevant articles were included for this study.

3.5 Extraction of data

A comprehensive data extraction process was performed on the articles to avoid redundancy of information. A detailed record of the data thus retrieved from the databases was maintained into an excel worksheet (woa.xlsx). Then, several categorization processes were performed on the data such as application-wise categorization (fields and subfields), method-wise categorization (Modification, Hybridization and Multi-objective, etc.), year-wise

Table 1 WOA in major academic databases

Online databases	Article returned
SpringerLink	95
IEEE Xplore	31
ISI Web of Sciences	38
Scopus	93
Taylor & Francis Online	1
ScienceDirect	98
Emerald	0
ACM Digital Library	0
Google Scholar	583
Total	939

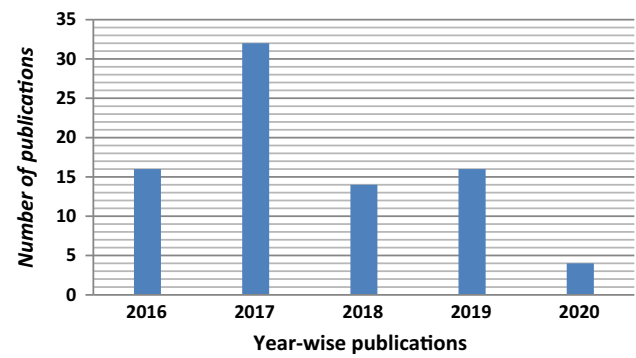

Fig. 7 Number of publications per year

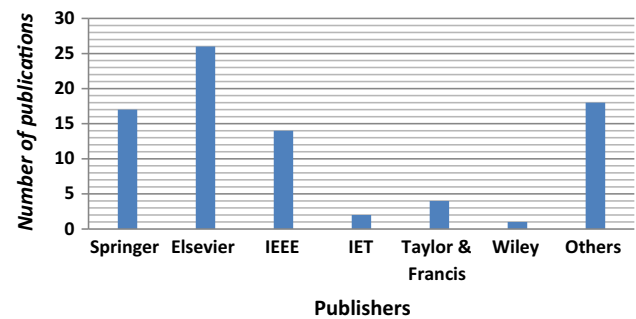

Fig. 8 Number of articles by publishers

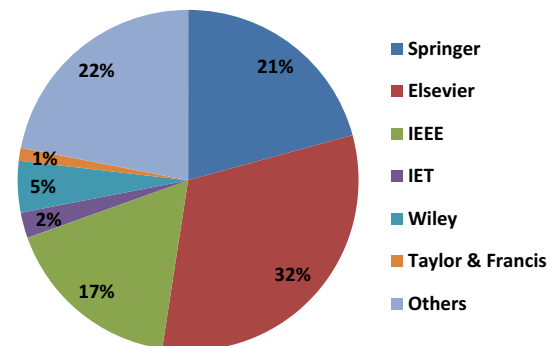
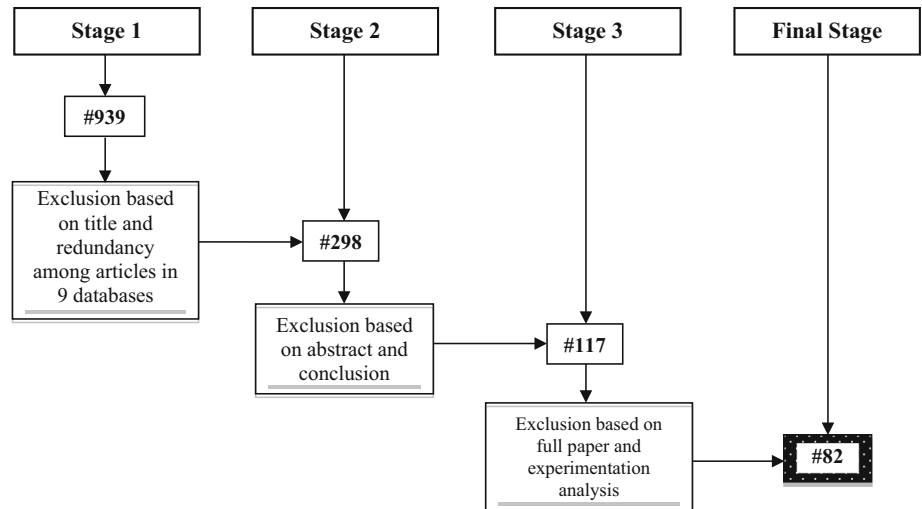

Fig. 9 Percentage of articles by publishers

distribution of articles, and publisher-wise distribution. Then the tabulated data were audited by two different reviewers to eradicate all chances of discrepancy in results. Some records were also eliminated from the dataset following the recommendations of the reviewers. The data inclusion and exclusion processes are shown in Fig. 10. We searched through 9 authentic online databases (Table 1), which returned 939 articles. Mismatch of the titles, irrelevance of fields of study, and redundancy of information moved us to discard 641 articles. In the second phase, the abstracts and conclusions of the remaining 298 articles were read to refine the selection. The texts of the 117 articles were thoroughly read and the results of the experiments scrutinized to make the selection precise, in

Fig. 10 Data inclusion and Exclusion stages



the third stage. The rigorous selection process finally returned 82 articles highly suitable for the study.

4 Application of WOA

Literary works has shown several areas of application of WOA to address real-world problems. Most of the studies investigated its performance in comparison with other benchmark meta-heuristics and various traditional

optimization methods. The application of WOA is growing rapidly in multiple disciplines due to its efficiency and easily adaptable features. In this section, we delineate the applicability of the WOA in different areas, and sub-areas of engineering domains as the main objective of our review. Based on our study on selected articles, we categorize the application of WOA in five major fields and several subfields and present taxonomy in Fig. 11. Furthermore, the number-wise works are mentioned in Fig. 13 and the percentage-wise works in each field are shown in

Fig. 11 Application of WOA in different fields and subfields

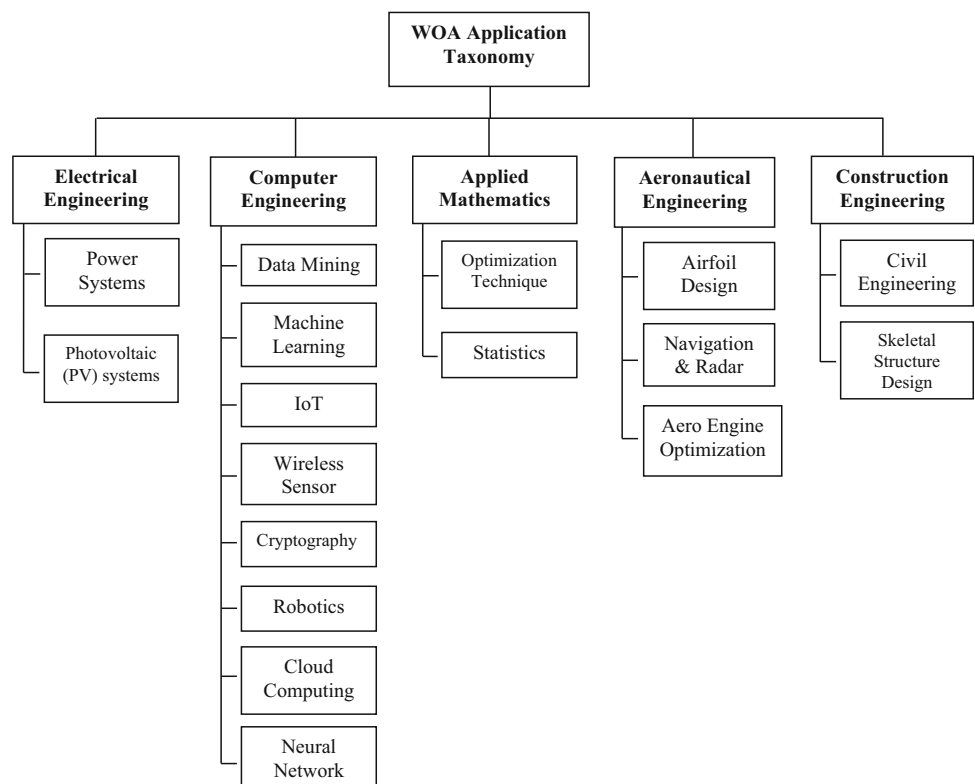

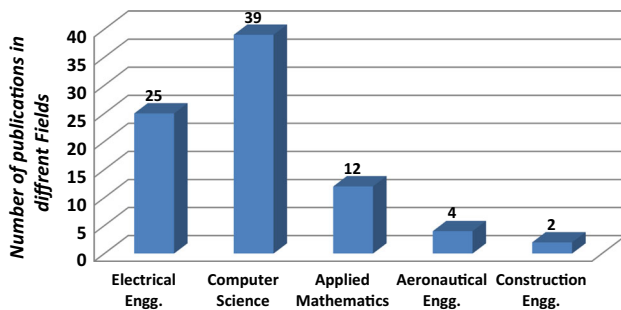

Fig. 12 Number of WOA articles in different fields

Fig. 12. Although we have not categorized our review based on the methods (like, modification, hybridization etc.) used in the selected articles, we have discussed it exclusively as and when needed in our review. The method-wise classification of the research works are mentioned in Table 2 and Fig. 15.

4.1 Application of WOA in electrical engineering

The WOA has been primarily used in electrical engineering discipline to solve a variety of low-dimensional, unimodal complex problems. Proper problem formulation, better design of objective functions and suitable use of variables can be resulted as an efficient system development regardless of any engineering domain. Moreover, appropriate use of operators, parameter setting, and population illustration is the main concern when designing a better optimization algorithm. The study shows that the applicability of WOA has shown excellent performance in solving a variety of optimization problems in several fields and subfields of engineering. Several modifications, hybridizations, and multi-objective versions of WOA methods have been developed and applied by the researchers that are discussed in the next subsection. A taxonomy of WOA-based method is presented in Fig. 16, and the comparative summary of filed-wise literature is demonstrated in Tables 3, 4, 5, 6 and 7. Tables 8, 9 and 10 display the common matrices used in the selected literature.

4.1.1 Modification-based application to power system problem

Touma [95] presented a meta-heuristic optimization strategy based on WOA to solve Economic Dispatch (ED) problem in engineering design. The algorithm is tested and verified using standard test system IEEE 30-Bus. The results illustrate a remarkable reduction in power output, total loss and total cost delivering optimum solution. Further, the algorithm showed a significant improvement compared to some benchmark meta-heuristic algorithms like PSO, ACO and GA. In a micro electric grid, Combined Economic Emission Dispatch (CEED) is a basic problem, in which scheduling of generating units within their limits with minimizing fuel cost and emission values is a challenging task. In order to tackle this challenge, Trivedi et al. [96] applied WOA and achieved a significant amount of reduction in cost and total emission for all resources. These scholars compared the performance of proposed method with existing methods like gradient method (GM), ACO, and PSO with two different cases, without emission and with emission on economic load dispatch (ELD) system.

In another development, WOA is adopted to solve the emission constrained economic dispatch (ECED) problem. In which, a multi-criteria problem can be transformed into single criteria using price penalty factor method to minimize total emission value and total fuel cost [97]. In the same way, Trivedi et al. [97] integrated a modern randomization adaptive technique with the novel WOA to solve the global optimization problem. The authors, in their work, introduced a hybrid technique namely adaptive whale optimization technique (AWOA) to achieve global optimal solution and faster convergence with less parameter dependency. The proposed algorithm is tested with ten benchmark functions and the results proved that the method is effective for solving crucial problems within unknown search space. Nazari-Heris et al. [69] exploited WOA to handle non-convex combined heat and power dispatch (CHPED) optimization problem in power system. The authors tested the capability of the proposed algorithm with three similar test systems and compared with benchmark time-varying acceleration coefficients particle swarm optimization (TVAC-PSO) and real-coded genetic algorithm with improved muhlenbein mutation (RCGA-IMM)

Table 2 Classification of method-wise studies

Methods	Studies
Modification-based WOA	[1, 5, 6, 12, 15, 16, 25, 29, 31, 32, 37–40, 42, 43, 47, 49, 54, 56, 60, 63–67, 69–71, 75, 77, 78, 80, 81, 83–85, 87, 93, 95–98, 102, 110–112, 116]
Hybrid-based WOA	[7, 8, 13, 17, 18, 23, 24, 30, 36, 41, 55, 61, 68, 73, 76, 79, 89, 94, 99, 107, 113, 115]
Multi-objective-based WOA	[2, 20, 33, 44, 62, 74, 91, 100, 103, 108]

Table 3 Application analysis of WOA in electrical and power system problems

References	Method/technique	Problems addressed	Proposed method	Improvement/achievement	Comparison	Test system
Cherukuri and Rayapudi [18]	Optimization technique	Maximum power point (MPP)	MPPT based on WOA	Improved efficiency and accuracy by maximizing tracking speed Reduced energy consumption	GWO and PSO	Tested on 6S, 3S2P and 2S3P photovoltaic array
Reddy et al. [79]	Optimal placement of DG	Optimal sizing of DG	WOA-based index vector methods	Reduced system loss Voltage profile improvement	Not available	IEEE 15, 33, 69 and 85-bus test systems
Bentouati et al. [13]	Power system planning	Optimal power flow problem	Hybrid WOA-PS algorithm	Improved voltage profile improvement Reduced fuel cost, total power loss and CO ₂ emission	Pattern search (PS), ACO, GA, HGA, EGA, HGA, ANN, PSO, and fuzzy HPSO	IEEE 30-bus system
Touma [95]	Optimization method	Economic dispatch problem	WOA-based algorithm	Reduced total fuel cost	PSO, ACO, and GA	IEEE 30-bus system
Prakash and Lakshminarayana [74]	Multi-objective optimization	Optimal sizing and placement for capacitors for a radial distribution system	WOA-based multi-objective optimization	Reduced operating cost by stabilizing the line losses and bus voltage	PSO, PGS, MINLP, and BFOA	IEEE-34 and IEEE-85 bus radial distribution test systems
Oliva et al. [71]	Chaotic-based technique	Parameter estimation for photovoltaic cell design	Chaotic-based technique	Achieved better configuration for solar cell Improved accuracy and robustness	CWOA, BMO, and STBLO	SD model
Ladumor et al. [56]	Optimization technique	Unit commitment problem	WOA-based algorithm	Reduced power generation cost	PSO, ILR, B.SMP, A.SMP, LRPSO, BDE, and GA	4-unit test systems
Trivedi et al. [96]	Scheduling technique	Combined economic emission dispatch problem (CEED)	WOA-based algorithm	Minimized resource load Reduced fuel cost and emission value	Gradient method (GM), ACO, and PSO	Economic load dispatch (ELD)
Bhesdadiya et al. [16]	Optimization technique	Optimal power flow (PPF)	WOA-based algorithm	Reduced fuel cost, active power loss, and reactive power loss	Flower pollination algorithm (FPA) and PSO	IEEE-bus 30 system
Trivedi et al. [97]	Price penalty factor technique	Emission constrained economic dispatch (ECED)	WOA-based algorithm	Reduced fuel cost and emission Transformed a multi-criteria problem to single criteria	Penalty factors: Min–Max, Max–Max, Min–Min, Max–Min, average, and common	IEEE-30 bus 6 generating unit systems

Table 3 (continued)

References	Method/ technique	Problems addressed	Proposed method	Improvement/ achievement	Comparison	Test system
Prasad et al. [75]	Chaotic-based technique	Optimal power flow (OPF) and transient stability constrained OPF (TSCOPF) problem	CWOA algorithm	Reduced total fuel cost Improved quality solutions, effectiveness and convergence speed	DSA, TSCOPF-CM, TSCOPF-DM, CRO, WOA	New England 10-generator, 39-bus, 17-generator, and 162-bus test systems
Kumar et al. [55]	Optimization technique	Maximum Power point tracking (MPPT) problem	Hybrid WOA with differential evolution (WODE)	Improved accuracy and speed to track global maximum power point (GMPP)	GWO and IPSO	SPV fed battery load by using a boost converter
Elazab [29]	Parameter estimation method	Parameters estimation method for single and double-diode PV system	WOA-based PV model	Improved accuracy	PSO, and GA	Kyocera polycrystalline KC200GTPV
Nazari-Heris et al. [69]	Optimization problem	Combined heat and power economic dispatch (CHPED) problem	WOA-based optimization method	Improved operational cost Implemented on large systems	TVAC-PSO, and RCGA-IMM	84-Unit and 96-unit test systems
Marimuthu et al. [62]	Optimization problem	Allocation and sizing of DGs in distribution systems	WOA-based multi-objective optimization method	Reduced power loss Improved power factor stability	Not available	IEEE 69 bus radial distribution system
Rosyadi et al. [81]	Optimization problem	Optimal filter placement and sizing	WOA-based algorithm	Reduced power losses Maintained total harmonic distortion (THD) within prescribed limits	Not available	13-bus test system
Raj and Bhattacharyya [77]	Optimization problem	Optimal placement of TCSC and SVC	WOA-based algorithm	Reduced power loss and operating cost while maintaining voltage profile	DE, and GWO	Standard IEEE 30 and IEEE 57 bus test systems
Hasanien [32]	Optimization problem	Photovoltaic power system	WOA-based PI control strategy	Improved dynamic performance of PV systems	GRG algorithm-based PI controller	PSCAD/EMTDC environment
Neagu et al. [70]	Optimization method	Optimal capacitor allocation in distribution system	WOA-based algorithm	Improved voltage profile Reduced power loss	PSO	Real distribution network

Table 3 (continued)

References	Method/ technique	Problems addressed	Proposed method	Improvement/ achievement	Comparison	Test system
Ben Oualid Medani et al. [12]	Optimization method	Optimal reactive power dispatch (ORPD) problem	WOA-based algorithm	Reduced power loss	PSO and PSO-TVAC	IEEE 14-bus, IEEE 30-bus, in 114-bus test system
Nandal and Kumar [67]	Optimization method	Constellation mapping for 2-dimensional and 3-dimensional signals cases	Optimal signal mapping scheme (MIMO-BICM-ID)	Optimized signal mapping	BER, Existing BSA, and BWOA	2-D QPSK, 3-dimensional 8 QAM, and 3-dimensional QPSK
Yan et al. [103]	Allocation technique	Water resource allocation optimization problem	Ameliorative whale optimization algorithm (AWOA)	Convergence speed and precision	WOA, and PSO	MATLAB (MATLAB 9.0, R2016a) Pareto front
Simhadri et al. [87]	Optimization method	Automatic generation control (AGC) problem	Two-degree-of-freedom state feedback controller (2DOFSFC)	Improved dynamic performance	ZN, GA, CPSO, and hFA-PS	Two-area thermal system with GDB nonlinearity and multi-units of hydrothermal interconnected power system
Yin et al. [108]	Optimization method	Electric vehicle charging station locating problem	Improved whale optimization algorithm (IWOA)	Improved precision and computing speed	WOA, Gauss_WOA, DE_WOA and AFSA_WOA	Tested on 9 benchmark function
Zhang et al. [111]	Optimization method	Optimal selection of hydropower system	Non-dominated sorting WOA (NSWOA)	Reduce cost Maximize total output power Minimize monthly power output	NSGA-II	Hydro-PV-wind power generation plant-South west China

methods. The simulation result shows better performance in all cases.

Owing to its fast convergence rate and random selection method, Bhesdadiya et al. [16] employed an improved WOA to solve optimal power flow (OPF) problem by modifying its parameters. When tested with the similar techniques such as FPA and PSO, the proposed technique has shown better results concerning power loss and fuel cost reduction. In a similar work, Ben Oualid Medani et al. [12] examined a case study of Algerian electric power grid by applying the newly developed WOA-based method to solve optimal reactive power dispatch (ORPD) problem. The researcher tested the proposed method on different benchmark power bus system to measure its effectiveness. They have also applied the technique to large-scale Algerian electric 114-bus power system to prove its validity. Furthermore, the author compared the proposed method with existing state-of-art PSO and PSO-TVAC method. In

all cases, the proposed method showed fast convergence speed and better power loss reduction.

The modification to improve the performance of WOA is carried out by Prasad et al. [75] with chaotic parameter optimization method to solve an extended power flow problem called transient stability constraint (TSCOPF) problem. By introducing chaotic variable, improvement in the convergence speed led to the balance between local search and random search of the proposed method. The proposed method is validated on two similar test-bus systems and compared with the existing optimization techniques. The results showed the capability of the proposed method in terms of optimal solution, effectiveness and higher convergence cover, also a significant reduction in fuel cost. With the significance of voltage fluctuation problem in power system, Neagu et al. [70] proposed a novel WOA-based approach, in which the optimal placement of the capacitor is measured to solve voltage variation problem. They compared the obtained result by WOA with

Table 4 Application analysis of WOA in data mining and machine learning problems

References	Techniques	Problems addressed	Proposed method	Improvements	Comparison	Measures/dataset
Hassanien et al. [34]	Text mining	Text extraction	Fuzzy-based hybrid WO algorithm	Improved performance and accuracy	Otsu, Niblack, and Triangle	F-measure, distance reciprocal distortion (DRD), peak signal-to-noise ratio (PSNR), geometric accuracy, negative rate metric (NRM)
El Aziz et al. [28]	Segmentation	Image segmentation	Multi-level threshold image segmentation hybrid method	Improved Otsu's fitness function	SCA, HS, WOA, MFO, SSO, FASSO, and FA	PSNR, and SSIM
Jadhav and Gomathi [41]	Clustering	Data clustering	WGC hybrid clustering technique	Improved F-measure, Rand coefficient, accord coefficient, and MSE metrics	PSC, mPSC, GWO, EGWO, KEGWO, and WOA	UCI machine learning repository, Banknote authentication dataset, Iris dataset, Wine dataset
Wang et al. [100]	Prediction	Wind speed forecasting	Hybrid system based (MOWOA) and hybrid CEEMD-MOWOA-ENN	Prediction accuracy improved	MOALO and MODA	16 benchmark models
Mafarja and Mirjalili [61]	Classification	Feature selection	WOA-based wrapper feature selection approach (WOA-CM)	Classification accuracy	PSO, GA, and ALO	CFS FCBF F-Score IG Spectrum on 20 datasets
Zamani and Nadimi-Shahraki [109]	Classification	Feature extraction	FSWOA for feature selection	Reduced the dimension of medical datasets in diseases diagnosis with an acceptable accuracy	Not available	Pima Indians Diabetes, original Wisconsin breast cancer, statlog and hepatitis
Saidala and Devarakonda [82]	Classification	Feature selection	WOA-SVM framework	Improved precision, accuracy, recall and F-measure	Not available	Enron-spam dataset
Sharawi et al. [85]	Classification	Feature selection	WOA-based wrapper feature selection model	Classification accuracy	PSO and GA	18 dataset UCI
Hassan and Hassanien [33]	Segmentation	Feature extraction	Hybrid multilevel thresholding model	Improved overall accuracy	Receiver operating characteristic (ROC)	Boston diagnostic center dataset (Fayoum city)

Table 4 (continued)

References	Techniques	Problems addressed	Proposed method	Improvements	Comparison	Measures/dataset
Mostafa et al. [66]	Segmentation	Clustering	WOA-based segmentation method	Improved accuracy	Wolf local thresholding + RG, Morphological operations + RG, K-means +RG, ABC, gray wolf	70 MRI images, structural similarity index measure (SSIM), similarity index (SI) and other five measures, GM, FM, PR, SP, and ACC
Mafarja and Mirjalili [60]	Classification	Feature selection	Hybrid wrapper selection model	Improved classification accuracy	Ant Lion Optimizer (ALO), PSO and GA	18 dataset UCI
Sayed et al. [84]	Classification	Feature Extraction	SVM-quadratic-based classifier model	Improved precision, accuracy, recall and F-measure	GA, PCA, MI, SD, RSFS, SFFS and SFS	WBCD from the UCI repository
Aljarah et al. [8]	Classification	Training of MLP network	WOA-MLP model for MLP training	Improved classification accuracy and convergence speed	WOA, BP, GA, PSO, ACO, DE, ES, and PBIL	20 UCI datasets Repository 1 and DELVE repository
Tharwat et al. [94]	Classification	Drug toxicity prediction	WOA + SVM model	Achieved high classification rate High sensitivity shown on drug samples	WOA + SVM, k-NN, NB and LDA	553 drugs dataset that bio-transformed in liver Sampling method: RUS, ROS, SMOTE, BLSMOTE, SLSMOTE, SMOTE, BLSMOTE, SLSMOTE
Zhao et al. [115]	Forecasting	CO ₂ emissions prediction and forecasting	WOA-LSSVM (least squares support vector machine) model	Improve forecasting accuracy	FOA-LSSVM, LSSVM, and OLS (ordinary least square)	CO ₂ emissions dataset in China
Desuky [23]	Classification	Male fertility rate categorization	Primal estimated sub-gradient solver for SVM (Pegasos) using WOA	Better classification and prediction accuracy	Pegasos, SVM, MLP, DT, ANN, NB, and PSO	100 semen samples analyzed according to WHO (World Health Organization)
Bhesdadiya et al. [15]	Classification	Multilayer perceptron (MLP) training problem	WOA-based MLP trainer	Increased accuracy in neurons training and optimal weight for MLPs Greater local optima avoidance	GWO and PSO	XOR, balloon, Iris, breast cancer, and heart
Hussien et al. [40]	Classification	Dimensionality reduction and classifications problem	Binary version of whale optimization algorithm (bWOA-S)	Classification accuracy	WOA	11 UCI benchmark datasets

Table 4 (continued)

References	Techniques	Problems addressed	Proposed method	Improvements	Comparison	Measures/dataset
Miao et al. [64]	Classification	Feature Extraction	Optimal swarm decomposition (OSWD)	Resolve mode mixing problem Frequency and time	SWD	Not available
Jain et al. [43]	Classification	Feature Selection	MWOA usability model	Improved classification accuracy	WOA, MBBAT, and BBAT	SDLC models datasets
Nasiri and Khiyabani [68]	Clustering method	Data Clustering	WOA-based clustering method	Improved Performance	k-means, DE, GA, ABC, and PSO	ART, Iris, Wine, CMC, Balance, Cancer, Glass, Thyroid UCI datasets
Dhabal and Saha [24]	Image enhancement	Image extraction	DEWOA	PSNR and entropy	PSO, ABC, CSA, and FPA	Gray-level images like Lena, vegetable, and ship
Alameer et al. [7]	Forecasting	Gold price prediction	WOA-NN-based forecasting model	Improve performance Decrease RMSE	NN, PSO-NN, GA-NN, and ARIMA	Not mentioned
Bui et al. [17]	Neuro-fuzzy inference system	Land image classification	Hybrid WANFIS classification model	Improved classification accuracy	Decision tree, random forest, and SVM	RMSE, MAE, AUC, Kappa, and OA
Dixit et al. [25]	Deep learning	Pattern recognition	Modified CNN + WOA for pattern recognition	Improved classification accuracy	T-CCN-3, KNN + nLBP, RALBGC, and LBP	Kylberg v1.0, Brodatz, and Outex_TC_00012
Tubishat et al. [99]	Machine learning	Sentimental analysis	IWOA model	Improved classification accuracy	WOA, DE, IWOA, PSO, GA, ALO, and GOA, KNN, and NB	OCA, Arabic twitter, Political, and Software
Qiao et al. [76]	Prediction	Short-term gas consumption prediction	IWOA hybrid model	Improved prediction accuracy	COA, FOA, IGA, and IPSOA	PSR-GS-VAF, PSR-GS-VAF-IWOA, GS-BPNN, GS-GRNN, GS-ELMANNN, and GS-LSSVM
Yin et al. [107]	Classification	Brain tumor image classification	IWOA and MLP-IWOA hybrid model	Improved classification accuracy	GA, firefly algorithm, and brain storm optimization	Wine, Dermatology, and Cleveland
Zhang et al. [113]	Clustering method	Community detection	WOCDA method	Improved communities in the networks	AFSA, BA, iMeme-net, and DPSO	Karate, Football, Dolphins, Facebook, Jazz, and Email etc.

PSO. The results showed that the proposed algorithm improved voltage profile and minimized power loss.

In a similar kind of study, Rosyadi et al. [81] extended WOA to find optimal size and placement of passive harmonic filters. They have tested the proposed method on the 13-bus system to validate the obtained result. The simulation results showed that the proposed method outperformed other similar technique and showed better performance to improve voltage profile and power loss

reduction. Similarly, in another progress in Ladumor et al. [56], the same bio-inspired WOA is adopted to solve unit commitment problem in distributed electric power generation. The authors compared the proposed algorithm with the classical PSO, ILR, B.SMP, A.SMP, LRPSO, BDE and GA algorithms to test its convergence speed and validity. The results display the WOA outperforms related to speed and lower power generation cost. Raj and Bhattacharyya [77] applied WOA to find the optimal solution for flexible

Table 5 Application analysis of WOA in other domains of computer science problems

References	Methods/ techniques	Problem addressed	Proposed method	Improvements	Comparison	Test system/ environment
Ahmed et al. [5]	Discrete-binary optimization	Lifetime improvement of WSNs	WOTC topology control protocol	Minimized numbers of active nodes Reduced energy consumption	SACR protocol, EADC, energy-balanced topology control, PSO and A3 topology	Java-based simulation tool called Atarraya
Dao et al. [20]	Multi-objective Optimization	Robot path planning	Multi-objective WO algorithm (MWOA)	Decreased path distance Increased smoothness for robot Error rate reduced	Multiple-objective genetic algorithms (MOGA)	Simulation based configuration of parse solution
Sreenu and Sreelatha [91]	Task scheduling	Task scheduling in cloud computing	W-Scheduler for task scheduling	Minimized makespan and cost	PBACO, SLPSO-SA, and SPSO-SA	CloudSim environment
Al-Janabi and Al-Raweshidy [6]	Clustering method	Sensor resource restrictions and random diversification of node density	Proposed CC-WOA protocol	Reduce energy consumption	PSO-C	LEACH and SEP
Reddy and Babu [78]	Clustering method	Cluster head selection problem	Adaptive whale optimization (SAWOA)	Minimized energy consumption, distance, and delay of sensor nodes Improved load balancing and temperature	ABC, GA, PSO, GSA, AGSA	WSN-IoT network.
Kumar and Chaparala [54]	Clustering method	Clustering of WSN nodes	OBC-WOA	Minimized energy, throughput, network packet delivery Increased network lifetime	FKM-CMA, WOA, PSO, and GSA	Not mentioned
Abdel-Basset et al. [1]	Cryptography	Cryptanalysis	Modified version of WOA (MWOA) for cryptanalysis of MHKC	Improved robustness of the system	GA, BPSO, MBPSO, IGA, DA and FA	Not available
Abdel-Basset et al. [2]	Job scheduling	Flow shop scheduling problem (FSSP)	HWA method	Makespan and total flow time	Hybrid GA (HGA), Hybrid BA (HBA), Hybrid CS (HCS) etc.	Carlier, Reeves, Heller, and Taillard benchmarks

AC transmission (FACT) devices in reactive power planning. The researchers tested the validity of proposed method on IEEE-30 and IEE-57 bus systems. The obtained results from the proposed method are compared with the other meta-heuristics differential evolution (DE) and gray wolf optimization (GWO). The simulation results showed the significant improvements in voltage profile maintenance while reducing the power loss and total operating cost of the reactive power system. Nandal and Kumar [67]

introduced a cost function using WOA to find an optimal constellation mapping scheme for bit-interleaved coded modulation (BICM) system. The proposed method tested on different multi-dimensional cases. The authors claim that the method can send information without any signal loss.

Table 6 Application analysis of WOA in applied mathematics optimization problems

References	Methods/ techniques	Problem addressed	Proposed method	Improvements	Comparison	Test functions
Xu et al. [102]	Optimization functions	High-dimensional continuous function optimization problems	Improved whale optimization algorithm (IWOA) with inertia weight	Improved mean value and performance	ABC and fruit fly	Tested on 31 benchmark functions
Jangir and Jangir [44]	Multi-objective optimization	Multi-objective optimization problem in engineering design	Non-dominated sorting whale optimization algorithm (NSWOA)	Improved execution time (ET) and effectiveness	MOCBO, MOPSO, NSGA-II and MOSOS	Tested on 17 multi-objective case studies, 8 unconstrained test functions, 5 constrained test functions, and 4 real-world engineering design problems
Trivedi et al. [98]	Adaptive technique	Randomization problem	Adaptive WOA (AWOA)	Improved performance	Sphere, Schwefel, Rosenbrock's function, step function, quartic function, penalty function	Tested on many benchmark and convergence functions
Zhou et al. [116]	Optimization technique	Optimization problem	Lévy flight trajectory-based whale optimization algorithm (LWOA)	Improved diversification and global search ability and local minima avoidance	MFO, PSO, GSA, BA, ABC, and WOA	23 benchmark functions and infinite impulse response (IIR) model identification
Mirjalili and Lewis [65]	Meta-heuristic technique	Optimization problem	WOA meta-heuristic algorithm	Improved competitive performance	29 Math functions and 6 structural design	Benchmark math functions and structural design
Kaur and Arora [47]	Chaotic optimization	Tuning the parameter	Chaotic WOA (CWOA) method	Improved the performance Balanced the controlling parameter to find the optimal solution Improved convergence rate	20 benchmark functions dividing into multimodal and unimodal problems	Not available
Elaziz and Mirjalili [30]	Automated chaotic method	Optimization problem	Hyper heuristic chaotic DEWCO	Improve exploration Improved convergence speed and better local optima avoidance	GWO, SCA, ABC, SSO, MFO, MVO	35 benchmarks functions from CEC2005
Hussien et al. [39]	Optimization technique	Discrete optimization problem	bWOA-S and bWOA-V—binary WOA	Better performance and convergence speed	BPSO, BBA, bGWO1, bGWO2 and GA	22 benchmark functions and 3 engineering optimization problems
Hemasiyan-Etefagh and Safi-Esfahani [37]	Group-based meta-heuristic technique	Early convergence problem and balancing exploitation and exploration	Group-based WOA	Improved exploration Better convergence speed and local optima avoidance	PSO, BAT	Friedman's test

Table 6 (continued)

References	Methods/ techniques	Problem addressed	Proposed method	Improvements	Comparison	Test functions
Ghahremani-Nahr et al. [31]	WOA-based discrete method	Resource allocation problem	Mixed integer nonlinear programming (MINLP)	Reduced cost and time	GAMS	Not available
Sun et al. [93]	Optimization technique	High-dimensional global optimization problem	Quadratic interpolation based method (QIWOA)	Improved performance and convergence speed	WOA, LWOA, and OBWOA	30 high-dimensional benchmarks functions
Heidari et al. [36]	Optimization technique	Early convergence problem	BMWOA	Improved performance and convergence speed	GWO, PBIL, WOA, PSO, BAT, GA, WOA, FA, BBO, and SCA	CEC 2017 test suite

Table 7 Application analysis of WOA in aeronautical and construction engineering problems

References	Methods/ techniques	Problem addressed	Proposed method	Improvements	Comparison	Test system
Zhang et al. [110]	Linear antenna array optimization	Synthesis of uniformly excited broadside linear aperiodic arrays	WOA-based approach	Improved linear aperiodic arrays synthesis Achieved lowest maximum sidelobe level	CLPSO, IWO-WDO, and MOEA/D-DE	Not available
Huang et al. [38]	Optimization technique	Aero-engine optimization	WOA-based optimization process	Improved search capacity Improved engine performance and acceleration capacity	Not available	Not available
Kaveh and Ghazaan [49]	Optimization technique	Weight minimization of skeletal structures	Enhanced whale optimization algorithm (EWOA)	Improved solution accuracy, reliability and convergence speed	HPSACO, HBB-BC, ICA, CSS, and CBO	3-Bay 24-Story Frame, 3-Bay 15-Story Frame, Spatial 582-Bar Tower, Spatial 72-Bar Truss Problem
Rohani et al. [80]	Planning and scheduling technique	Workflow planning of construction site	WOA-based planning of workspace conflicts	Reduced cost and time Spatial conflict decreased	Not available	Not available
Zhang et al. [112]	Optimization technique	Fault diagnosis of rolling element bearings	WOA-OMP method	Efficiency and accuracy	GA-MP method with Gabor dictionary and fast kurtogram method	Accelerometers type 4508, Bearing type HRB6304
Mehne and Mirjalili [63]	Optimization technique	Optimal control problems	WOA-based method	Reduced number of iterations Better convergence and accuracy	Invasive weed optimization (IWO), PSO, GA, Exact solution	Continuous Stirred Tank Reactor (CSTR), Low-Thrust Rendezvous

Table 8 Comparison of metrics used in electrical and power system

Sr. no.	Reference	CO ₂ emission	Fuel cost	Accuracy	Power loss	Operating cost	Voltage profile	Global tracking speed	Performance
1	Cherukuri and Rayapudi [18]			✓				✓	✓
2	Reddy et al. [79]				✓		✓		
3	Bentouati et al. [13]	✓	✓		✓		✓		
4	Touma [95]		✓						
5	Prakash and Lakshminarayana [74]					✓	✓		
6	Oliva et al. [71]		✓						✓
7	Ladumor et al. [56]					✓			
8	Trivedi et al. [96]	✓	✓						
9	Bhesdadiya et al. [16]		✓		✓				
10	Trivedi et al. [97]	✓	✓						
11	Prasad et al. [75]		✓					✓	✓
12	Kumar et al. [55]			✓				✓	
13	Elazab [29]			✓					
14	Nazari-Heris et al. [69]					✓			
15	Marimuthu et al. [62]				✓				
16	Rosyadi et al. [81]				✓				
17	Raj and Bhattacharyya [77]				✓	✓	✓		
18	Hasanien [32]								✓
19	Neagu et al. [70]				✓		✓		
20	Ben Oualid Medani et al. [12]				✓				
21	Nandal and Kumar [67]								✓
22	Yan et al. [103].							✓	
23	Simhadri et al. [87]								✓
24	Zhang et al. [111]		✓						
25	Yin et al. [108]				✓				

4.1.2 Hybridization-based application to power system problem

Bentouati et al. [13] proposed a hybrid algorithm termed as WOA with pattern search (WOA-PS) for solving complex optimal power flow problem. The authors in their work improved the performance of WOA by combining PS algorithm to enhance local search and to tackle the problem efficiently. The use of PS algorithm increased the exploitation capability by allowing the whales to cluster around the best solutions at each run of search. As per the results, the novel WOA-PS performed better than the basic WOA and other benchmark algorithms in order to achieve multi-objective criteria.

Distribution system is becoming the major concern nowadays, due to the fact that a significant amount of losses have been observed in the distribution of Distributed Generator (DG) units. Reddy et al. [79] studied the

performance of WOA and applied it to find the optimal sizing and placement for DG units in electric power system. The proposed system is evaluated on similar benchmark test systems and compared with different state-of-the-art evolutionary algorithms. The results depict that the algorithm achieved the best-known solution for DG placement.

4.1.3 Modification-based application in electric photovoltaic (PV) system

PV systems are rapidly extending to the electric grid, and thus several optimization methods have been developed to maintain the stability of PV system. Hasanien [32] proposed an improved version of meta-heuristic approach based on WOA to enhance the performance of PV power system. In this work, the author used WOA to design a control parameter based on proportional integrator (PI),

Table 9 Comparison of metrics used in data mining and machine learning

Sr. no.	Reference	Accuracy	Performance	F-measure	Precision	Recall	Convergence speed	MSE	Accord coefficient	Rand coefficient	PSNR	SSIM	Execution time
1	Hassanien et al. [34]	✓	✓										
2	El Aziz et al. [28]	✓	✓										
3	Jadhav and Gomathi [41]			✓				✓	✓	✓	✓	✓	✓
4	Wang et al. [100]	✓											
5	Mafarja and Mirjalili [61]	✓											
6	Zamani and Nadimi-Shahraki [109]	✓											
7	Saidala and Devarakonda [82]	✓		✓	✓	✓							
8	Sharawi et al. [85]	✓											
9	Mostafa et al. [66]	✓											
10	Hassan and Hassanien [33]	✓											
11	Mafarja and Mirjalili [60]	✓		✓	✓	✓							
12	Sayed et al. [84]	✓											
13	Aljarah et al. [8]	✓					✓						
14	Tharwat et al. [94]	✓											
15	Zhao et al. [115]	✓											
16	Desuky [23]	✓											
17	Bhesdadiya et al. [15]	✓											
18	Hussien et al. [40]	✓											
19	Miao et al. [64]	✓											✓
20	Jain et al. [43]	✓					✓						
21	Nasiri and Khayabani [68]	✓											
22	Dhabal and Saha [24]										✓		
23	Alameer et al. [7]												
24	Bui et al. [17]	✓											
25	Dixit et al. [25]	✓											
26	Tubishat et al. [99]	✓											
27	Qiao et al. [76]	✓											
28	Yin et al. [107]	✓											
29	Zhang et al. [113]	✓											

Table 10 Comparison of metrics used in others domains of computer science, applied mathematics, aeronautical engineering and construction engineering

Sr. no.	Reference	Total time	Makespan	Cost	Robustness	Load balancing and temperature	Performance	Execution time	Energy consumption	Decreased path distance	Convergence rate	Error rate
1	Ahmed et al. [5]					✓			✓			
2	Dao et al. [20]									✓		✓
3	Sreenu and Sreelatha [91]		✓	✓					✓			
4	Al-Janabi and Al-Raweshidy[6]								✓			
5	Reddy and Babu [78]					✓			✓	✓		
6	Abdel-Basset et al. [1]	✓	✓		✓							
7	Abdel-Basset et al. [2]	✓	✓									
8	Xu et al. [102]						✓					
9	Jangir and Jangir [44]						✓	✓				
10	Trivedi et al. [98]						✓					
11	Zhou et al. [116]						✓					
12	Mirjalili and Lewis [65]						✓					
13	Kaur and Arora [47]						✓				✓	
14	Zhang et al. [110]											
15	Huang et al. [38]						✓					
16	Kaveh and Ghazaan [49]											
17	Rohani et al. [80]							✓				
18	Zhang et al. [112]			✓								
19	Mehne and Mirjalili [63]										✓	
20	Elaziz and Mirjalili [30]										✓	
21	Hussien et al. [39]										✓	
22	Hemasiyan-Etefagh and Safi-Esfahani [37]						✓				✓	
23	Ghahremani-Nahr et al. [31]	✓		✓								
24	Sun et al. [93]						✓				✓	
25	Heidari et al. [36]						✓				✓	
26	Kumar and Chaparala [54]								✓			

which is used to control DC chopper and grid-side inverter to achieve its goal. They have tested the proposed method on RSM (response surface methodology) to examine its efficiency and compared with similar method. The simulation results prove a significant improvement in performance. In another study, Elazab [29] presented a modified meta-heuristic WOA-based model to analyze the parameter of single and double-diode of a PV model. The generated results are evaluated by comparing the opted values of $I-V$ and $P-V$ characteristic curve under the standard test conditions (STCs) in various environments. The simulation results show that the WOA has acceptable performance with other existing methods.

Due to the problem of having useful model to characterize the solar panel and the lack of sufficient photovoltaic data, designing a photovoltaic cell for solar panel is a complex task. In order to tackle this issue, Oliva et al. [71] presented a meta-heuristic algorithm called chaotic whale optimization algorithm (CWOA) to find the optimal parameter estimation for the solar cells. The chaotic map approach automatically computes and adapts the internal parameters of the optimization algorithm and helps to find the best configuration for the solar cell. When compared with the similar models and methods, the proposed model gives better results and also improves performance and accuracy. In a similar work, a multi-objective non-dominated sorting whale optimization algorithm (NSWOA) is proposed by [108] for optimal selection of hydropower systems. The results show the proposed model performs well in terms of maximizing the total output power and minimizing the standard deviation of monthly power output. The system also performs well with respect to the increased size of the problem.

In Zhang et al. [111], an improved whale optimization algorithm is proposed by introducing Gaussian mutation, differential evolution and crowding degree factor operators to address the problem for locating charging station for electrical vehicles. The proposed technique demonstrates better results in terms of improving precision and computation time and also reduces the total operating cost significantly. Similarly, Simhadri et al. [87] tuned the classic WOA to develop two-degree-of-freedom state feedback controller (2DOFSFC) for automatic generation control (AGC) problem. The technique applied on two different area thermal power system to evaluate its sensitivity and performance. The simulation results generated through the proposed algorithm showed better performance in comparison with other state-of-the-art algorithms.

4.1.4 Hybridization-based application in electric photovoltaic (PV) system

An evolutionary hybrid method called whale optimization-based differential evaluation (WODE) technique is presented by Kumar et al. [55] for solving maximum power point tracking problem in dynamic and partially shaded solar PV system. The authors in their work improved the performance of WOA by introducing DE technique which prevents it from trapping into stagnation state. Moreover, it reduces the number of spiral path (iteration number). The DE first chooses the best three positions for the whales decided by WOA, which all has to go through mutation, crossover, and selection process. Finally, it decides the best position of the whales among three. Therefore, in each iteration WOA gets an extra support by DE, which reduces the size of population and the number of iterations. As per the results, the performance of WODE proved to be superior as compared to other state-of-the-art methods. It is also quicker, reliable and system independent.

In Cherukuri and Rayapudi [18], a novel maximum power point tracking (MPPT) method based on WOA is proposed to analyze analytic modeling of PV system considering both series and shunt resistances for MPP tracking under PSC. The authors in their work implemented the WOA as a direct control MPPT technique, i.e., duty cycle control by taking population of whales as duty ratios to reduce steady state oscillations. Direct control MPPT decreases power loss and therefore improves efficiency of the system. To compare the performance, GWO and PSO-MPPT algorithms are also simulated and results are also presented. The results of the simulations demonstrated that their proposed MPPT method has a superior performance to other MPPT methods with reference to accuracy and tracking speed.

4.2 Application of WOA in computer science

The swarm intelligence WOA has shown a significant imprint to solve optimization problem in computer science (CS) and engineering domain. According to the conducted studies in this survey, variants of WOA with its modifications and hybridization have demonstrated tremendous results. Also, various multi-objective version of WOA has been developed in solving various domains of computer science problems, such as data mining and machine learning, cloud computing, WSN, signal and systems, and robotics, etc. Tables 4 and 5 demonstrate a summary of applications of WOA in various domains of computer science. Similarly, the matrices used in CS domains are mentioned in Tables 9, 10, respectively. In the next subsection, we discuss the methods applied in computer science and engineering.

4.2.1 Modification-based application in data mining and machine learning

Mostafa et al. [66] used bio-inspired WOA to solve image segmentation problem for MRI scanned live images. In this work, WOA is used to find the optimal solution to create fixed number of image clusters and then multiplied by binary statistical image to remove unwanted organ parts. The proposed model is evaluated on Structural Similarity Index Measure (SSIM), Similarity Index (SI) and similar measures using various bio-inspired segmentation methods to test the accuracy of segmented images. The statistical results showed that the WOA-based model outperforms significantly other methods and enhanced the accuracy up to 97.5%. Saidala and Devarakonda [82] hybridized the classic WOA with support vector machine (SVM) to solve email classification problem. The bubble-net hunting behavior of the algorithm is used to identify the optimal structure from the Enron-spam dataset. The SVM classifier is tested on four different kernel functions, such as *Linear*, *Quadratic*, *Polynomial* and *RBF* to identify the best function, whereas four different performance metrics are utilized. The result showed superior performance of the proposed method with other similar methods in terms of accuracy.

In a similar kind of work, WOA is applied in a wrapper-based manner to select the best features from the datasets. The proposed algorithm is compared with other state-of-the-art PSO and GA using 18 different UCI repository datasets. The WOA is found to be very competitive with other methods [85]. In the same way, an improved WOA for feature selection, called feature selection based on whale optimization algorithm (FSWOA), is presented by Zamani and Nadimi-Shahraki [109] to reduce the dimensionality of the dataset and to enhance the performance of the classifier. The performance of the proposed algorithm is evaluated on four standard medical datasets and functions. The simulation results showed that the proposed algorithm reduced the dimensionality of medical datasets with acceptable accuracy for diseases diagnosis.

In a similar work, a wrapper-based feature selection method is applied to improve classification accuracy. In this work, WOA is implemented in binary manner. At first, the algorithm uses roulette wheel selection method for global search, then crossover and mutation methods are performed for local search in order to select the subset from the generated solutions. The proposed model outperforms three other benchmark meta-heuristic approaches and five different feature selection filter methods in terms of finding optimal subset in a very less time [60]. Similarly, a meta-heuristic-based method namely swarm decomposition (SWD) is put forward to extract the bearing fault features from the machine signals. The proposed OSWD helps in

selecting the threshold of the faulty SWD signals. When compared with the other similar method, the proposed method outperforms in terms of solving mix mode problem [64].

Hussien et al. [40] proposed a binary version of whale optimization algorithm (bWOA) for feature selection. In the first phase of the feature selection process, S-shaped transfer function is applied to convert the continuous search space into binary search space so that the whales are forced to move their position between 0 to 1 and vice versa. Once the features selection is done, then K-NN classifier is applied to test the relevance of the selected features. The experimented results showed that the proposed method outperforms classic WOA in terms of classification accuracy and better fitness value. In another progress, Jain et al. [43] introduced a modified version of WOA, namely MWOA, by introducing inertia weight parameter to tackle the problem of features selection in the usability model in software quality. The simulation results show that the proposed method achieves better accuracy in feature selection in comparison with the other six SDLC usability models. In the same vein, Dixit et al. [25] investigated a pattern recognition problem by applying WOA to optimize the capability of the convolutional neural network (CNN). In their proposed model, WOA is first applied for optimizing the value of filter in the convolution layer, and then it optimizes the value of weights and biases in a fully connected layer. The model shows obvious potential when applying on some of the renowned datasets in classification accuracy.

4.2.2 Hybridization-based application in data mining and machine learning

The performance of WOA becomes more powerful, if it is integrated with fuzzy set theory. In this regard, Hassanien et al. [34] proposed a WOA-based approach for image binarization of handwritten Arabic manuscript, where fuzzy c-means objective function is utilized to obtain the optimal thresholds. The incorporation of fuzzy c-mean with WOA results in significant enhancement of manuscript which suffers from noise and degradation. It worked well in terms of visual inspection and objective performance measures. Determining optimal threshold in image segmentation is a time-consuming and challenging task, especially when the threshold number increases. In El Aziz et al. [28], hybridization-based method is proposed by combining WOA and moth-flame optimization (MFO) algorithm to find the optimal multi-level threshold value for image segmentation. Furthermore, they compared the two algorithms with some other benchmark algorithms. The experimental results showed that the WOA outperforms

other algorithms in terms of fitness function and achieved feasible threshold.

The emergence of artificial neural network as an important tool in the domain of artificial intelligence and optimization could not over emphasize. Aljarah et al. [8] studied the performance of the WOA for the training of artificial neural networks and evaluate its obtained results with other stochastic methods that worked on the same problem instances. The authors tested the WOA trainer on 20 datasets with different levels of difficulty drawn from the UCI and DELVE machine learning repository. Similarly, the results proved that the proposed trainer is able to outperform the current algorithms on the majority of datasets in terms of both local optima avoidance and convergence speed. Bhesdadiya et al. [15] anticipates the performance of WOA to train the multilayer perception in artificial neural networks to solve the classification problem. The authors have evaluated the result generated from the proposed algorithm and compared with other methods that focus the similar problem. The WOA efficiently performs in terms of effectiveness and accuracy to train Multilayer perception (MLP) and to avoid local optima problem. Mafarja and Mirjalili [61] combined the novel WOA with SA to develop a hybrid technique to solve feature selection problem on medical dataset. The work to find optimal features is performed in two phases: at first, WOA locates the best region to search and then simulated annealing (SA) is used to improve the exploitation phase to find the optimal solution. The authors evaluated the performance of the proposed technique on 18 reliable datasets from UCI repository and compared with three state-of-art methods. The experimental data confirmed the efficiency of the proposed method to find optimal features attributes from the data with optimal accuracy.

In another progress, Jadhav and Gomathi [41] hybridize WOA with exponential gray wolf optimizer (EGWO) and named it WGE to generate optimal data clustering. The proposed algorithm computes the centroid of the data based on minimum fitness function, which ultimately build the clusters containing all important details about the data. The performance of the proposed algorithm is found very competitive when compared with other datasets and similar methods. A hybridization-based application in Machine Learning is introduced in Zhao et al. [115]. In their work, the authors presented a hybrid model named as whale optimization algorithm-based least squares support vector method (WOA-LSSVM) for CO₂⁻ emission forecasting. The authors extended the LSSVM technique by optimizing its parameter using WOA. When compared with FOA (fruit fly optimization algorithm)-LSSVM, single LSSVM, and Ordinary Least Square (OLS) hybrid forecasting method, the proposed method showed superiority in prediction accuracy as well as its simple applicability. Sayed et al.

[84] employed WOA to find optimal feature selection for classification of breast cancer diagnosis. In this work, the author used three components (i.e., encircling prey, bubble-net attacking method, and search for prey) of WOA to develop a classifier model. They examined the model over Wisconsin Breast Cancer Database (WBCD) from UCI repository to evaluate four crucial measurements, such as precision, accuracy, recall, and f-measure. The results proved that the method produced a significant performance in terms of high classification accuracy, precision, recall and f-measure. Desuky [23] presented two levels of enhancement technique by combining WOA and Primal Estimated Sub-Gradient Solver (Pegasos) for SVM to solve the classification problem in medical database. They have proved by their results that WOA performs better in second level enhancement rather than Pegasos, which is used in the first level of enhancement in categorization of male fertility data.

Measuring toxicity is an important step in drug development. Tharwat et al. [94] developed a computational model to predict the toxicity of the drug in its initial stage of development by combining WOA with Support SVM classifier. The solution approach is divided into three stages: in the first stage (feature selection), the most irrelevant features are removed using rough set-based methods to reduce classification time. Then, the data are pre-processed in order to obtained balanced samples in each class. Moreover, the selected features and pre-processed dataset are used to train SVM classifier in the third stage (classification phase) in order to classify an unknown drug into toxic or non-toxic effects. The authors evaluated the proposed model with some well-known classifiers. The results clearly demonstrate the approach outperformed some existing state-of-the-art approaches. Aljarah et al. [9] anticipated the efficiency of WOA and use it to train the neural network parameters. The proposed WOA-MLP is applied to find the optimal values for the weights and biases parameters so that the mean square errors (MSE) can be minimized. The authors commend with their experimental results that the proposed trainer is very efficient compared to the state-of-art six meta-heuristic approaches applied on 20 different benchmark datasets.

In recent progress, Nasiri and Khiyabani [68] applied a WOA-based approach in clustering problems in data mining. The method is applied on several benchmark datasets from the UCI repository for classification of the data points to form optimal clusters. Moreover, the proposed method is compared with the benchmark meta-heuristic algorithms such as *k*-means, DE, GA, ABC, and PSO to test its validity. The proposed WOA is shown superior performance for classification with greater accuracy. In view of gold price prediction as a significant concern in the data mining community, Alameer et al. [7] presented a meta-

heuristic WOA-based long term, forecasting model. In this method, WOA is employed with NN as a trainer to work as multilayer neural networks (NN). The hybrid model WOA-NN is tested on the ARIMA benchmark model for its validity and found efficient in terms of improved forecasting accuracy as per the simulation graph. It also surpasses the performance compared to other benchmark hybrid methods like NN, PSO-NN, GA-NN, and ARIMA. Unlike previous works Bui et al. [17], extended a hybrid model WANFIS by tuning the parameter of classic neuro-fuzzy inference system. The method is employed for feature reduction of land cover image classification. The model outperforms in terms of classification accuracy when tested on several benchmark classifiers and statistical indicators.

In the same context, Tubishat et al. [99] improved the classic WOA to overcome local entrapment problems and used for sentimental analysis (SA) in Arabic text. At first, an elite opposition-based learning is incorporated in the initialization (EOBL) phase of the model, and then DE is utilized to improve the local search mechanism of the model. In order to reduce the global search, the information gain (IG) filter is used with WOA and SVM for feature selection. The improved IWOA is applied to four benchmark datasets in the Arabic language to test its validity and found very competitive in removing irrelevant features for the document. When compared to state-of-the-art meta-heuristics and deep learning algorithms, the IWOA exhibits superior performance in classification accuracy in SA. Likewise, a hybridization of DE and WOA is done to enhance the digital image considering the intensity of the image. The proposed DEWOA used for finding the cost function using local and global output. As shown in the simulation results, the proposed method outperforms other methods such as PSO, ABC, CSA, and FPA in terms of significant parameter enhancement like PSNR and entropy [24].

Qiao et al. [76] suggested a short-term natural gas consumption prediction model, which is the combination of the Volterra adaptive filter and WOA. The simulation results show that the proposed method outperforms other state-of-the-art methods with high prediction accuracy. In another progress, Yin et al. [107] proffered a chaotic-based classification model for brain tumors image extraction using improved IWOA. In this work, the IWOA is used for feature selection and feature extraction by reducing the overfitting fitness value and removing the similar features from the datasets. Moreover, the multilayer perception-based MLP-IWOA is employed for classification on the extracted datasets. The simulation graphs demonstrate the better performance of the proposed method with better classification accuracy. Moreover, a WOA-based community detection algorithm (WOCDA) is proposed by Zhang

et al. [113], where they adopted three unique hunting behaviors of the classic WOA in their work. In the initialization phase, optimal nodes are generated by label diffusion and propagation method, and then shrinking encircling is performed based on the current node against the most suitable neighboring node. Moreover, the spiral update is formed using a crossover operator. Finally, in order to improve the global search, a random search is initiated to find the best neighboring solution for labeling the node and consequently update is performed. The proposed method is validated by experimenting on some popular real-world network communities and also compared with state-of-the-art algorithms. The simulation results confirm its performance in detecting better communities compared to other benchmark community detection algorithms.

4.2.3 Modification-based application of WOA in IoT

The emergence of IoT and high-dimensional WSN has a coherent issue to handle resources inside the cluster area network, which ultimately leads to performance degradation. Al-Janabi and Al-Raweshidy [6] applied the potential of WOA to discover the best cluster heads to considering the resource limitation and heterogeneous nature of nodes in different geographical area. The simulation result showed that the proposed method is capable of managing the resources which increased network life time and packet sink. Similarly, the presentation of WOA for the design of self-adaptive cluster head selection technique and protocol, namely SAWOA, is discussed in Reddy and Babu [78], in which the cluster head selection is optimized to manage different parameters of WSN. When compared to different similar meta-heuristic algorithms based of different parameters like load and temperature, the proposed technique improved the performance and network lifetime.

4.2.4 Modification-based application in wireless sensor network

In this study, the modification of discrete version of WOA is provided to enhance the lifetime in wireless sensor network. The proposed WOA for topology control (WOTC) is designed to consider binary fitness functions as a main optimization problem. The algorithm acts for the minimization of the active nodes. Consequently, the energy consumption of the computer nodes is reduced and the lifetime of the WSNs is enhanced [5]. In wireless sensor network (WSN), energy management of the sensors is considered as one of the major issues. A novel modification-based WOA-C is presented by Jadhav and Shankar [42] to perform optimal selection of cluster nodes to solve energy management problem. The method computes the

leftover battery energy of the adjacent sensor nodes in WSNs area to select the best energy-aware nodes. The proposed method is compared with several similar protocols to validate its performance and found very competitive in terms of residual energy and network lifetime enhancement. Kumar and Chaparala [54] proffered an opposition-based chaotic whale optimization algorithm for the clustering of the nodes in the WSN to reduce energy consumption. The proposed OBC-WOA is designed to optimize the cluster heads on the network with greater precision and accuracy. The simulation results show substantial performance by the proposed algorithm in terms of energy reduction, throughput, and network packet delivery and also increase the lifetime of the network.

4.2.5 Modification-based application in cryptography

In cryptography, Merkle-Hellman cryptosystem (MHKC) is considered one of the legacy systems, which allows a secured communication between sender and receiver. A modified version of algorithm called MWOA is proposed by Abdel-Basset et al. [1] for cryptanalysis of the MHKC cryptosystem. In this work, a sigmoid function is incorporated for the mapping of continuous value to the discrete value. Then, to remove infeasible solution, a penalty function is employed, and finally mutation function is used to get the improved optimal solution. The results of the proposed method outperform compared to other meta-heuristic approaches in terms of robustness and effectiveness.

4.3 Modification-based WOA in applied mathematics

Kaur and Arora [47] introduced a chaotic CWOA algorithm based on chaos theory to improve the convergence speed of the base WOA. Several chaotic maps are used to tune up the parameters to find optimal solution. A comprehensive study has been performed on 20 benchmark functions to validate its performance. It is observed that the proposed method significantly improved the performance of the base algorithm and found efficient in solving optimization problem. To deal with the randomization problem, while local and global searching space Trivedi et al. [98] introduced an adaptive technique called adaptive whale optimization algorithm (AWOA). The authors claim with the results that their algorithm efficiently performed in solving global optimization problem with greater convergence speed.

In order to solve high-dimensional continuous function optimization problem, Xu et al. [102] introduced a new control parameter, inertia weight and came up with an improved whale optimization algorithm (IWOA) to tackle mathematical optimization problem. The algorithm tested

on 31 high-dimensional continuous benchmark functions and proved to be powerful search algorithm. The optimization results showed a considerable improvement in the basic WOA also outperformed ABC algorithm and the FOA. An improved WO algorithm is presented to tackle global optimization function by Zhou et al. [116], in which a better solution was generated by enhancing of diversification of search agent in order to accomplish local minima avoidance. The authors utilized a new Levy flight trajectory scheme to update the humpback whale position to achieve a better balance between the exploration and exploitation, and accelerated the global convergence speed. When evaluated with several standard benchmark functions to test its efficiency, it was found that the proposed algorithm depicts superior performance in comparison to original WOA. It is also highly competitive with other robust population-based methods.

By exploiting the drawback of opposition-based method which tends to obtain the initial population manually, Elaziz and Mirjalili [30] introduced a hyper-heuristic DEWCO method to automatize the process of population selection. The proposed method provides the best configuration with the help of DE algorithm which ultimately provides better initial population to WOA to fasten the convergence speed. The results show the proposed technique outperforms similar benchmark functions. The authors claim their technique be used in VM allocation in cloud computing. Hemasian-Etefagh and Safi-Esfahani [37] proposed an improved version of WOA-based technique to overcome the premature convergence problem of the WOA. In this technique, the whale populations are grouped and sorted according on their fitness; furthermore, the sorted populations are randomly selected by the technique for searching process. As per the results, the group-based technique shows better balance between exploitation and exploration and also able to avoid local optima problem.

In another study related to fuzzy, Ghahremani-Nahr et al. [31] designed a network model using mixed integer nonlinear programming (MINLP) to reduce cost. The proposed model is then developed and tested using robust fuzzy programming (RFP) under various uncertain parameters. In order to minimize the total network cost, WOA is applied with the modified discrete priority-based encoding method. When compared with similar solver, the proposed algorithm performs 13 times faster with fast computational rate also. Hussien et al. [39] proposed a binary version of WOA to solve discrete optimization problem. Two sigmoid transfer functions called S-shaped and V-shaped are introduced to enable the whales to move their position between 0 and 1 in the binary search space. The proposed exhibit superior results as compared to similar meta-heuristics algorithms when applied to twenty-two

benchmark functions and three engineering optimization problems.

By exploiting the deficiency of classic WOA in solving high-dimensional problems and tends to trap in local optima, Sun et al. [93] anticipated a quadratic interpolation-based method (QIWOA) for solving the optimization problem. A new parameter is set into improve the global search in the exploration phase and to improve convergence speed. On the other hand, quadratic interpolation is used to improve the local search in the exploitation phase. The proposed technique is experimented with almost 30 benchmark functions and compared with several state-of-the-art algorithms to test its validity; in almost all the cases, it shows better performance and a right balance between exploration and exploitation. In the same context, Heidari et al. [36] addressed the premature convergence problem as a primary issue of WOA in its exploitation phase. To overcome the problem, exploitative behavior is modified with the help of the association of learning mechanism. Moreover, the local search based hill-climbing method is employed to further improve the exploitation process. The simulation results confirm that the proposed outperforms contemporary methods and algorithms.

4.4 Modification-based application in aeronautics engineering

Aftab et al. [4] highlights the unique capability and biological structure of humpback whale for solving aerodynamics design problem. The authors comprehensively review the work on tubercles which is found on the flipper of the humpback whale and its capability to generate a unique flow control mechanism. Furthermore, the authors claimed in their study that the flow pattern over the tubercle wing is quite different from conventional wings. The new design of aero plan incorporated with tubercle has 25% more airflow than conventional wind turbine blades and produces 20% more energy. Huang et al. [38] exploited WOA to improve their nonlinear programming-based model to optimize the performance of aircraft engine. Simulation results showed that using the proposed WAO-based method, the acceleration of the aero-engine is improved. In another progress, WOA is used to design a synthesis technique to equally distribute the broadside linear periodic arrays in radar navigation system. The proposed method achieved better improvements in solving nonlinear problems as shown by the study in [110]. In another progress, Zhang et al. [112] addressed fault monitoring and diagnosis problem in rolling bearings by introducing a hybrid method, where WOA is combined with optimized orthogonal matching pursuit (OMP) algorithm. In this method, at first a time–frequency-based atom dictionary is created to match better bearing fault features.

Then, the proposed method is employed to optimize the efficiency and accuracy of the signal sparse visualization. When compared to other benchmark methods, the proposed method showed better performance and notable ability to extract bearing fault features. Similarly, the optimal control flow problem is tackled using WOA-based numerical method by Mehne and Mirjalili [63]. In this, the authors exploit the potential of proposed WOA to implement the method in parallel processing by converting the multi-staging problem to finite-dimensional problem using smoothing process. Parallel execution of the method comparably reduced the time complexity. When compared to existing benchmark meta-heuristics method, the proposed method showed more smooth and accurate solutions.

4.5 Modification-based application in construction engineering

An improved WOA is presented to tackle sizing optimization problem by Kaveh and Ghazaan [49], in which better solutions were generated in order to improve solution accuracy, reliability and convergence speed. The authors utilized a new scheme to modify convergence behavior of the WOA and accelerate the global convergence speed as well as preserving the simplicity and robustness of the basic WOA. When similar standard structural optimization problems are employed to verify the efficiency of the method, it was found that the proposed algorithm has a superior performance with the original WOA and highly competitive with other population-based methods. Rohani et al. [80] adopted the WOA to handle time–space conflict problem in workflow planning problem in construction site. In this investigation, the workspaces were created based on the analysis and shaping of construction resources and building elements. Then, the spatial conflicts between workspaces were identified visually in time-based simulation tool. Finally, WOA was implemented for optimizing the outputs variable such as time, cost and workspace simultaneously. The main objective of their research was to implement the integration of visual simulation modeling and optimization algorithm for planning of workspace conflicts. The implementation of the research on the case study showed that the project's cost and time as well as the number of spatial conflicts decreased dramatically in relation to normal and initial schedule.

4.6 Multi-objective-based application of WOA

The literature has shown the achievements of the WOA as a single-objective optimization algorithm to tackle complex problems in continuous and multi-dimensional search space. This has motivated the current researchers

to extend it to multi-objective algorithm. In this regard, Dao et al. [20] developed a multi-objective binary WOA, namely multi-objective whale optimization (MWAO), for mobile robot path planning. In this method, two criteria, distance and smooth path in path planning problem, have been addressed to minimize the path of the robot. The simulation results showed that the proposed method outperformed multi-objective genetic algorithm (MOGA) in terms of better quality and error rate. The introduction of the new and efficient WOAs to solve line loss problem in electrical distribution networks is proposed by Prakash and Lakshminarayana [74], where the optimal sizing and placement of capacitors for a typical radial distribution system is achieved. The researchers utilized the adaptability features of the proposed algorithm to tackle multi-objectives functions such as operating cost and power loss with inequality constraints of voltage limits. The algorithm is tested on IEEE-34 bus and IEEE-85 bus standards radial test systems. The experimental results showed that the proposed algorithm functions efficiently in bringing down the operating costs and maintains better voltage profile. Similarly, a novel multi-objective algorithm is proposed by Marimuthu et al. [62], the algorithm applied to find optimal placement and size of DG to solve power loss problem in distributed power system. Due to its high convergence speed and optimal solution generation capacity, the proposed WOA-based algorithm displayed high performance and better outcomes as compared to GA and PSO.

In Sreenu and Sreelatha [91], a multi-objective optimization technique W-Scheduler is proposed to cater task scheduling problem in cloud computing. The analysis of the obtained results depict that the proposed method is highly competitive compared to other methods in minimizing multi-objective cost and makespan in task scheduling. Wang et al. [100] presented a novel hybrid multi-objectives model, namely multi-objective whale optimization algorithm (MOWOA) to predict wind speed. The proposed model consists of four modules: preprocessing, optimization, forecasting, and evaluation. The MOWOA model is utilized to overcome the deficiency of single-objective function and to provide smoothness and better accuracy to support prediction process. When compared to other multi-objective models such as multi-objective ant lion optimizer (MOALO) and multi-objective dragonfly algorithm (MODA), the proposed model showed better performance. The authors also compared their model with six other similar models. The results showed that the presented model supersedes other models in terms of predictability and stability for wind speed forecasting.

In another progress, WOA is combined with multi-thresholding to build a model to solve image segmentation

problem in retinal fundus image. In the first phase, the technique improves the brightness of the retinal image. Then, the proposed hybrid model is applied to find the optimal level of threshold on the fundus image. The proposed model displayed high accuracy in separating retinal fundus image as shown in the results [33]. Similarly, an improved multi-objective algorithm called non-dominated whale optimization algorithm (NSWOA) is presented by Jangir and Jangir [44]. In this work, WOA is utilized for exploration purpose to find the optimal solution for crowding distance problem. A comprehensive set of testing is done to test its validity. Also, the comparison is performed with other state-of-the-art, constrained, unconstrained, and various multi-objective engineering methods. The experimental results demonstrate excellent performance in terms of speed and quality in finding optimal solutions for continuous and discrete optimization problems. A multi-objective model namely ameliorative whale optimization algorithm (AWOA) is developed to solve water resource allocation optimization problem by Yan et al. [103]. In this study, to improve the quality of swarm location, a logistic mapping technique is employed. Additionally, inertia weight is introduced to improve the local search capability. The experimental results showed that the proposed method outperforms basic WOA and PSO with regard to improved convergence speed and precision.

Abdel-Basset et al. [2] presented a hybrid whale optimization algorithm called HWA combining Nawaz–Enscore–Ham (NEH) for solving permutation flow shop scheduling problem (PFSSP). In the formation of HWA, the local search is improved by applying classic WOA, swap operation technique is utilized for local optima avoidance, and insert-reversed block function has been used to improve the quality of generated solutions. Moreover, largest rank value (LRV) is used to convert continuous value to discrete according to the job permutations. To check the validation, the proposed algorithm is examined on four state-of-the-art methods: Carlier, Reeves, Heller, and Taillard. The simulation results displayed a significant strength and the robustness in minimizing makespan and total flow time.

5 Open problems and future research directions

The modifications and advancements presented above show that the WOA has made great progress in recent years, but there are still some important research challenges that need further investigation.

5.1 Local and global search

Maintaining a balance between local and global search in the WOA and most meta-heuristic algorithms remains a big challenging issue. This is because the most efficient way to regulate exploration and exploitation is still an open research issue that needs more investigations. In spite of the many efforts to advance the WOA through modifications, an effective and efficient effort has not been arrived at that put forward a logical methodology of balancing local and global search in the WOA [57].

5.2 Generalization

A number of the surveyed WOA literatures indicate that some level of modification must be performed on the original WOA for it to fit into specific scenarios. This gives rise to many different problems with many different conditions and modified parameters. Consequently, we need different versions of the WOA emerge to solve the different problems in the different scenarios. No general algorithm. This issue of generalization is not specific to the WOA as most heuristics and meta-heuristic algorithms also suffered from this research problem. In general, a more comprehensive research of generalization and standardization in WOA and meta-heuristic will greatly improve their applicability in other research areas.

5.3 Sensitivity to parameters

Even though the WOA has less sensitivity to parameter settings in relation to other nature-inspired algorithms, the parameter setting remains a problem, because user-defined parameters are necessary for executing the WOA. Therefore, the most optimized parameters must be identified in order to have optimal solutions for each specific problem. This indicates that the attainment of the WOA still depend on selecting the most optimized parameter. More so, further research is required to produce an operational algorithm that will converge to the optimal solution to a problem with just little effort. In addition, research should also make attempt in the future to make WOA a parameter free. This means that parameter setting is not required for the algorithm to run.

5.4 Hybridization

Hybridization is recognized these days as a vital component of meta-heuristic algorithms research. A number of the conventional meta-heuristic algorithms particularly in soft computing include some modules inherited from other intelligence algorithms. Although the WOA also derived

some of its structures from other nature-inspired algorithms, integration with other algorithms needs to be researched more to upsurge its versatility. Conversely, hybridizations in most cases attain its boundary if significant problem instances with large search spaces become achievable solutions. Therefore, we recommend that more research should be carried out to hybridize other algorithms with the WOA.

5.5 Big data exploration

From the existing literatures reviewed above, there is more focus on the evaluation of the WOA modifications in small data sets. There is hardly any literature showing the application of the algorithms with big data which is the present reality of data science. This is even with the fact that big data have attracted enormous interest in scientific research and also in the industry. This is due to the estimated 2.5 quintillion bytes generated daily (Wu et al., 2014). Therefore, the superb efficiency of the advance WOA as distinguished in the recent literature is only limited to a small data set, not big data and therefore recommend to be extended.

6 Result and discussion

From the analysis of the literature in this survey, it has been observed that the WOA is being used in almost all popular fields of engineering domain for solving complex optimization problems. The favoritism of the meta-heuristic WOA as swarm intelligence optimization technique is rapidly increasing among the academia and industries since its inception, as depicted in Fig. 12. As per the results gathered from this literature survey, we can iterate that the application of WOA is undoubtedly expected to grow in various other relevant fields of engineering other than mentioned in this survey (electrical and power systems, computer engineering, aeronautical engineering, and construction engineering, Fig. 11). Several versions of WOA-based techniques are developed by researchers around the globe in the recent past to address numerous engineering optimization problems such as binary-based technique, fuzzy and neuro-fuzzy-based method, Levy flight-based method, and chaotic- and opposition-based learning methods. Among the surveyed works, chaotic-based and opposition-based learning methods are the most prevalent methods found in the literature for solving modern optimization problems. The trend of application of WOA in the various domains of engineering can be seen in Figs. 12 and 13, respectively. Where the application of WOA in computer science is 48%, followed by the application in Electrical engineering is 30%, application in applied

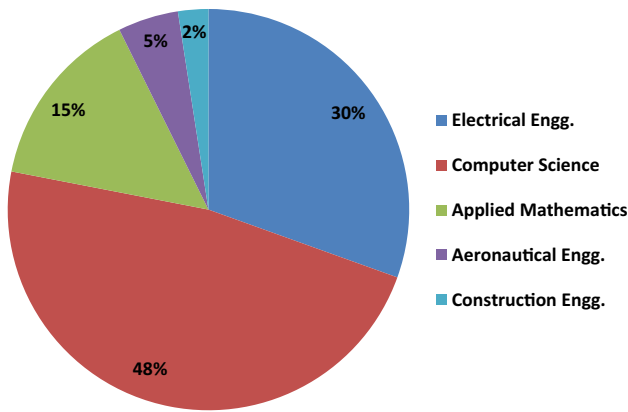

Fig. 13 WOA used in different fields in percentage

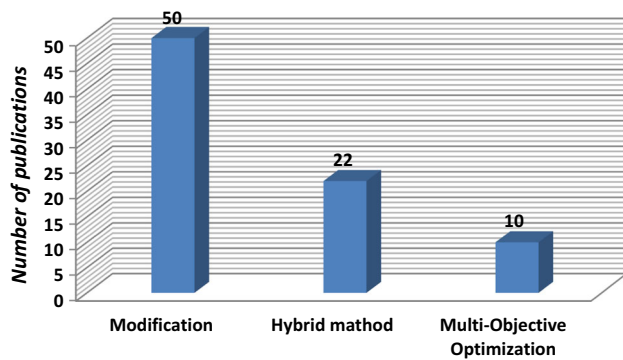

Fig. 14 Method-wise distribution of WOA in numbers

mathematics is 15%, application in aeronautical engineering is 5%, and application in construction engineering is 2%. Consequently, it can be seen that the application of WOA in the field of computer science is on the rise, followed by Electrical engineering. The parametric comparisons among the works in this survey show that the WOA can serve most of the standard matching parameters (Tables 8, 9, 10) as compared to other benchmark techniques such as GA, PSO, ACO, and SA. Also, as per the classification in Figs. 14 and 15, we found that 61% of works done in the literature are modification based, 27% of works are hybrid based, and 12% of works are multi-objective based. The application of the WOA has shown excellent results in its all variants and has proven its superiority in solving complex optimization problems.

7 Conclusion

Evolutionary-based algorithms are widely investigated meta-heuristic algorithms in engineering domains to address optimization problems. The rapid growth of the intelligent meta-heuristic algorithms in recent years inspired the researchers to explore its applicability in multi-

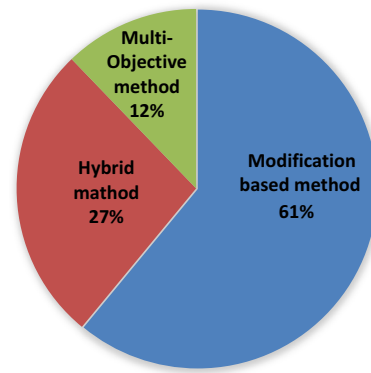

Fig. 15 Method-wise distribution of WOA in percentage

disciplinary fields. In the same vein, this review tries to explore the potentials of newly developed swarm-based meta-heuristic WOA through a systematic literature review. The study is based on WOAs: applications in different disciplines, modifications, and hybridizations, to tackle various combinatorial optimization problems. Despite the fact that the conception of this algorithm is very recent, its overwhelming growth in different areas is quite obvious (Figs. 12 and 13 for details). The obsession of today’s researchers toward WOA is due to its: (1) simple structure, (2) adaptability in dynamic condition, (3) solving low-dimensional and uni-model problems, (4) solving continues and convex problems, (5) local optima avoidance capability, (6) fast convergence speed due to its exploration and exploitation ability (Fig. 16).

Majority of the articles, reviewed in this study, are focused on, application of the algorithm, modification-based approach to a solution, hybrid method of a solution by combining other methods or algorithms, and parameter enhancements. However, there is room for improvement in the algorithm to solve the multi-dimensional and multi-model problems. Similarly, chaotic-based methods, discrete and binary-based methods, opposition- and fuzzy-based methods need a lot of work hours in the future research to solve complex optimization problems through WOA. The redesign of the multi-objective technique by tuning up the single-objective parameter into multi-objective parameters via the same algorithm could be another exciting area of improvements worth exploring.

A major portion of the works studied in this review is to solve the global optimization problem in high-dimensional space. Yet, other complex aspects, like optimal control problem using parallel numerical method, chaotic sequence problem, multiple knapsack problem, multi-class support vector machine problem, permutation flow shop problem, assignment problem, redundancy allocation problem and many more, can be taken into account for further research direction. This review investigates the applications of the

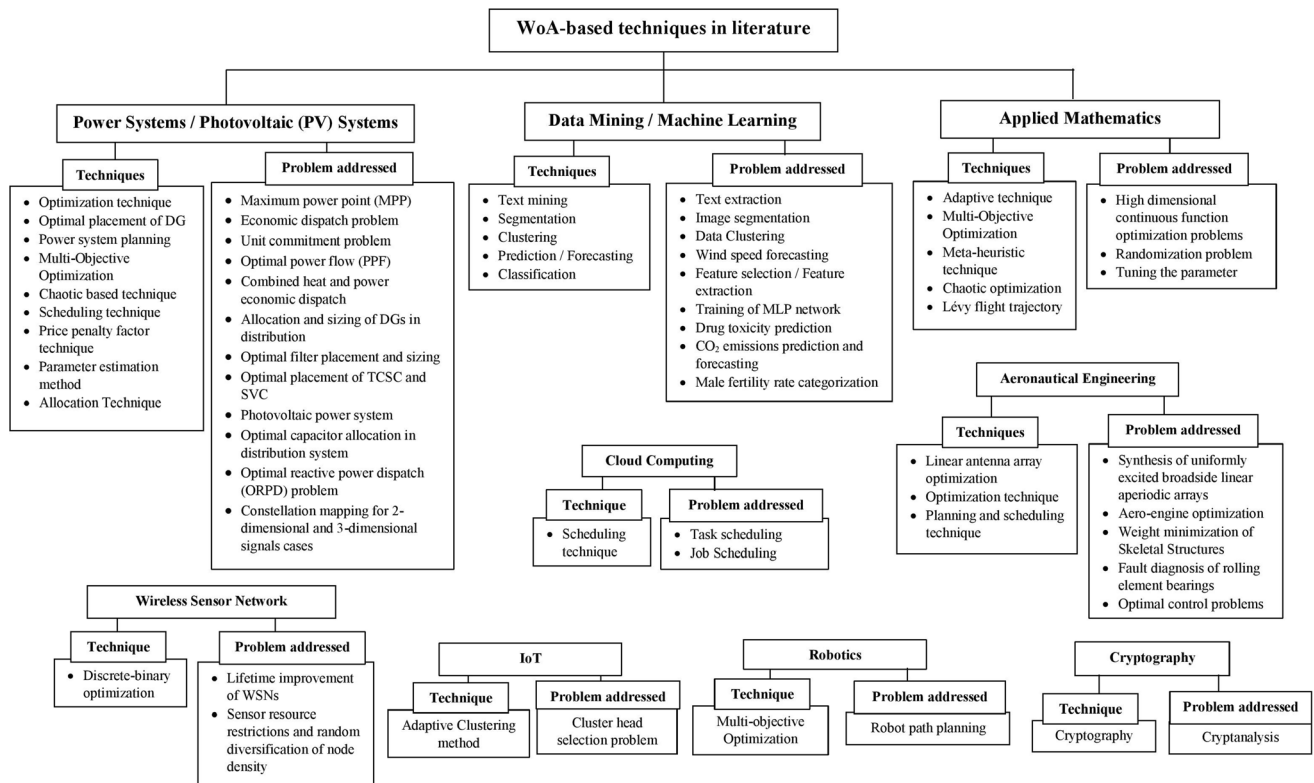

Fig. 16 WOA-based methods taxonomy in the literature

WOA in various fields and subfields of engineering domains for solving optimization problems. It opens a pathway to explore more interdisciplinary and multi-disciplinary fields that can be unraveled by the dexterity of WOA.

References

- Abdel-Basset M, El-Shahat D, El-Henawy I, Sangaiah AK, Ahmed SH (2018) A novel whale optimization algorithm for cryptanalysis in Merkle-Hellman Cryptosystem. *Mob Netw Appl* 1:1–11
- Abdel-Basset M, Gunasekaran M, El-Shahat D, Mirjalili S (2018) A hybrid whale optimization algorithm based on local search strategy for the permutation flow shop scheduling problem. *Fut Gen Comput Syst* 85:129–145
- Abdulhamid SM, Latiff MSA, Idris I (2015) Tasks scheduling technique using league championship algorithm for makespan minimization in IAAS cloud. *arXiv preprint arXiv:1510.03173*
- Aftab S, Razak N, Rafie AM, Ahmad K (2016) Mimicking the humpback whale: an aerodynamic perspective. *Prog Aerosp Sci* 84:48–69
- Ahmed MM, Houssein EH, Hassanien AE, Taha A, Hassanien E (2017) Maximizing lifetime of wireless sensor networks based on whale optimization algorithm. *international conference on advanced intelligent systems and informatics*. Springer, Berlin, pp 724–733
- Al-Janabi T, Al-Raweshidy H (2017) Efficient whale optimization algorithm-based SDN clustering for IoT focused on node density. In: 16th Annual Mediterranean on ad hoc networking workshop (Med-Hoc-Net). IEEE, pp 1–6
- Alameer Z, Elaziz MA, Ewees AA, Ye H, Jianhua Z (2019) Forecasting gold price fluctuations using improved multilayer perceptron neural network and whale optimization algorithm. *Resources Policy* 61:250–260
- Aljarah I, Faris H, Mirjalili S (2016) Optimizing connection weights in neural networks using the whale optimization algorithm. *Soft Comput* 22:1–15
- Aljarah I, Faris H, Mirjalili S (2018) Optimizing connection weights in neural networks using the whale optimization algorithm. *Soft Comput* 22:1–15
- Askarzadeh A (2014) Bird mating optimizer: an optimization algorithm inspired by bird mating strategies. *Commun Nonlinear Sci Numer Simul* 19:1213–1228
- Beheshti Z, Shamsuddin SMH (2013) A review of population-based meta-heuristic algorithms. *Int J Adv Soft Comput Appl* 5:1–35
- Ben Oualid Medani K, Sayah S, Bekrar A (2017) Whale optimization algorithm based optimal reactive power dispatch: a case study of the Algerian power system. *Electr Power Syst Res* 163:696–705
- Bentouati B, Chaib L, Chettih S (2016) A hybrid whale algorithm and pattern search technique for optimal power flow problem. In: 8th International conference on modelling, identification and control (ICMIC). IEEE, pp 1048–1053
- Bhattacharya A, Chattopadhyay P (2011) Application of biogeography-based optimisation to solve different optimal power flow problems. *IET Gener Transm Distrib* 5:70–80
- Bhesdadiya R, Jangir P, Jangir N, Trivedi IN, Ladumor D (2016) Training multi-layer perceptron in neural network using whale optimization algorithm. *Indian J Sci Technol* 9:28–36

16. Bhesdadiya R, Parmar SA, Trivedi IN, Jangir P, Bhoje M, Jangir N (2016) Optimal active and reactive power dispatch problem solution using whale optimization algorithm. *Indian J Sci Technol* 9:1–6
17. Bui Q-T, Pham MV, Nguyen Q-H, Nguyen LX, Pham HM (2019) Whale Optimization Algorithm and Adaptive Neuro-Fuzzy Inference System: a hybrid method for feature selection and land pattern classification. *Int J Remote Sens* 40:5078–5093
18. Cherukuri SK, Rayapudi SR (2016) A novel global MPP tracking of photovoltaic system based on whale optimization algorithm. *Int J Renew Energy Dev* 5:225–232
19. Chiroma H, Herawan T, Fister I Jr, Fister I, Abdulkareem S, Shuib L, Hamza MF, Saadi Y, Abubakar A (2017) Bio-inspired computation: recent development on the modifications of the cuckoo search algorithm. *Appl Soft Comput* 61:149–173
20. Dao T-K, Pan T-S, Pan J-S (2016) A multi-objective optimal mobile robot path planning based on whale optimization algorithm. In: *IEEE 13th International Conference on Signal Processing (ICSP)*. IEEE, pp 337–342
21. Dasgupta D, Michalewicz Z (2013) *Evolutionary algorithms in engineering applications*. Springer, Berlin
22. Deb K, Pratap A, Agarwal S, Meyarivan T (2002) A fast and elitist multiobjective genetic algorithm: NSGA-II. *IEEE Trans Evol Comput* 6:182–197
23. Desuky AS (2017) two enhancement levels for male fertility rate categorization using whale optimization and Pegasos algorithms. *Aust J Basic Appl Sci* 11:78–83
24. Dhabal S, Saha DK (2020) Image enhancement using differential evolution based whale optimization algorithm. In: *Emerging technology in modelling and graphics*. Springer, Berlin
25. Dixit U, Mishra A, Shukla A, Tiwari R (2019) Texture classification using convolutional neural network optimized with whale optimization algorithm. *SN Appl Sci* 1:655
26. Dorigo M, Birattari M (2011) Ant colony optimization. *Encyclopedia of machine learning*. Springer, Berlin
27. Dorigo M, Di Caro G (1999) Ant colony optimization: a new meta-heuristic. *Proceedings of the 1999 congress on evolutionary computation, CEC 99*. IEEE, pp 1470–1477
28. el Aziz MA, Ewees AA, Hassanien AE (2017) Whale optimization algorithm and moth-flame optimization for multilevel thresholding image segmentation. *Expert Syst Appl* 83:242–256
29. Elazab OS (2017) Whale optimization algorithm for photovoltaic model identification. *J Eng* 1:1
30. Elaziz MA, Mirjalili S (2019) A hyper-heuristic for improving the initial population of whale optimization algorithm. *Knowl-Based Syst* 172:42–63
31. Ghahremani-Nahr J, Kian R, Sabet E (2019) A robust fuzzy mathematical programming model for the closed-loop supply chain network design and a whale optimization solution algorithm. *Expert Syst Appl* 116:454–471
32. Hassanien HM (2018) Performance improvement of photovoltaic power systems using an optimal control strategy based on whale optimization algorithm. *Electr Power Syst Res* 157:168–176
33. Hassan G, Hassanien AE (2017) Retinal fundus vasculature multilevel segmentation using whale optimization algorithm. *Signal Image Video Process* 12:1–8
34. Hassanien AE, Elfattah MA, Abouelenin S, Schaefer G, Zhu SY, Korovin I (2016) Historic handwritten manuscript binarisation using whale optimisation. In: *IEEE international conference on systems, man, and cybernetics (SMC)*, 2016. IEEE, pp 003842–003846
35. Hazir E, Erdinler ES, Koc KH (2018) Optimization of CNC cutting parameters using design of experiment (DOE) and desirability function. *J For Res* 29:1423–1434
36. Heidari AA, Aljarah I, Faris H, Chen H, Luo J, Mirjalili S (2019) An enhanced associative learning-based exploratory whale optimizer for global optimization. *Neural Comput Appl* 1:1–27
37. Hemasian-Etefagh F, Safi-Esfahani F (2019) Group-based whale optimization algorithm. *Soft Comput* 1:1–27
38. Huang X, Wang R, Zhao X, Hu K (2017) Aero-engine performance optimization based on whale optimization algorithm. In: *36th Chinese control conference (CCC)*. IEEE, pp 11437–11441
39. Hussien AG, Hassanien AE, Houssein EH, Amin M, Azar AT (2019) New binary whale optimization algorithm for discrete optimization problems. *Eng Optim* 1:1–15
40. Hussien AG, Hassanien AE, Houssein EH, Bhattacharyya S, Amin M (2019) S-shaped binary whale optimization algorithm for feature selection. Springer, Berlin
41. Jadhav AN, Gomathi N (2017) WGC: hybridization of exponential grey wolf optimizer with whale optimization for data clustering. *Alex Eng J* 57:1569–1584
42. Jadhav AR, Shankar T (2017) Whale optimization based energy-efficient cluster head selection algorithm for wireless sensor networks. *arXiv preprint arXiv:1711.09389*
43. Jain R, Gupta D, Khanna A (2019) Usability feature optimization using MWOA. In: *International conference on innovative computing and communications*. Springer, pp 453–462
44. Jangir P, Jangir N (2017) Non-dominated sorting whale optimization algorithm (NSWOA): a multi-objective optimization algorithm for solving engineering design problems. *Glob J Res Eng* 1:1
45. Karaboga D, Basturk B (2007) A powerful and efficient algorithm for numerical function optimization: artificial bee colony (ABC) algorithm. *J Glob Optim* 39:459–471
46. Kashan AH (2011) An efficient algorithm for constrained global optimization and application to mechanical engineering design: league championship algorithm (LCA). *Comput Aided Des* 43:1769–1792
47. Kaur G, Arora S (2018) Chaotic Whale Optimization Algorithm. *J Comput Des Eng* 5:175–284
48. Kaveh A, Farhoudi N (2013) A new optimization method: dolphin echolocation. *Adv Eng Softw* 59:53–70
49. Kaveh A, Ghazaan MI (2016) Enhanced whale optimization algorithm for sizing optimization of skeletal structures. *Mech Based Des Struct Mach* 1:1–18
50. Kennedy J (2011) Particle swarm optimization. *Encyclopedia of machine learning*. Springer, Berlin
51. Khandelwal M, Faradonbeh RS, Monjezi M, Armaghani DJ, Majid MZBA, Yagiz S (2017) Function development for appraising brittleness of intact rocks using genetic programming and non-linear multiple regression models. *Eng Comput* 33:13–21
52. Knowles J, Corne D (1999) The pareto archived evolution strategy: a new baseline algorithm for pareto multiobjective optimisation. In: *Proceedings of the 1999 congress on evolutionary computation, 1999*. IEEE, pp 98–105
53. Koza JR, Bennett FH, Stiffelman O (1999) Genetic programming as a Darwinian invention machine. In: *European conference on genetic programming*. Springer, pp 93–108
54. Kumar MM, Chaparala A (2019) OBC-WOA: opposition-based chaotic whale optimization algorithm for energy efficient clustering in wireless sensor network. *Intelligence* 250:1
55. Kumar N, Hussain I, Panigrahi B (2017) MPPT in dynamic condition of partially shaded PV system by using WODE technique. *IEEE Trans Sustain Energy* 1:1
56. Ladumor DP, Trivedi IN, Jangir P, Kumar A (2016) A whale optimization algorithm approach for unit commitment problem solution. In: *Proceedings of the national conference advancement in electrical and power electronics engineering (AEPEE 2016)*, Morbi, India, 2016

57. Li S (2016) The art of clustering bandits. *Università degli Studi dell'Insubria*
58. Li S, Karatzoglou A, Gentile C (2016) Collaborative filtering bandits. In: *Proceedings of the 39th international ACM SIGIR conference on research and development in information retrieval*, 2016. ACM, pp 539–548
59. Liberati A, Altman DG, Tetzlaff J, Mulrow C, Gøtzsche PC, Ioannidis JP, Clarke M, Devereaux PJ, Kleijnen J, Moher D (2009) The PRISMA statement for reporting systematic reviews and meta-analyses of studies that evaluate health care interventions: explanation and elaboration. *PLoS Med* 6:e1000100
60. Mafarja M, Mirjalili S (2018) Whale optimization approaches for wrapper feature selection. *Appl Soft Comput* 62:441–453
61. Mafarja MM, Mirjalili S (2017) Hybrid whale optimization algorithm with simulated annealing for feature selection. *Neurocomputing* 260:302–312
62. Marimuthu A, Gnanambal K, Priyanka R (2017) Optimal allocation and sizing of DG in a radial distribution system using whale optimization algorithm. In: *International conference on innovations in green energy and healthcare technologies (IGEHT)*, 2017. IEEE, pp 1–5
63. Mehne HH, Mirjalili S (2018) A parallel numerical method for solving optimal control problems based on whale optimization algorithm. *Knowledge-Based Syst* 151:114–123
64. Miao Y, Zhao M, Makis V, Lin J (2019) Optimal swarm decomposition with whale optimization algorithm for weak feature extraction from multicomponent modulation signal. *Mech Syst Signal Process* 122:673–691
65. Mirjalili S, Lewis A (2016) The whale optimization algorithm. *Adv Eng Softw* 95:51–67
66. Mostafa A, Hassanien AE, Houseni M, Hefny H (2017) Liver segmentation in MRI images based on whale optimization algorithm. *Multimed Tools Appl* 76:24931–24954
67. Nandal V, Kumar S (2018) Optimal signal mapping scheme for MIMO-BICM-ID transmission over the different fading channel using whale algorithm. *Int J Eng Technol* 7:106–111
68. Nasiri J, Khiyabani FM (2018) A whale optimization algorithm (WOA) approach for clustering. *Cogent Math Stat* 5:1483565
69. Nazari-Heris M, Mehdinejad M, Mohammadi-Ivatloo B, Babamalek-Gharehpetian G (2017) Combined heat and power economic dispatch problem solution by implementation of whale optimization method. *Neur Comput Appl* 31:1–16
70. Neagu BC, Ivanov O, Gavrilas M (2017) Voltage profile improvement in distribution networks using the whale optimization algorithm. In: *9th International conference on electronics, computers and artificial intelligence (ECAI)*, 2017. IEEE, pp 1–6
71. Oliva D, el Aziz MA, Hassanien AE (2017) Parameter estimation of photovoltaic cells using an improved chaotic whale optimization algorithm. *Appl Energy* 200:141–154
72. Pan W-T (2012) A new fruit fly optimization algorithm: taking the financial distress model as an example. *Knowl-Based Syst* 26:69–74
73. Pouramirarsalani A, Khalilian M, Nikravanshalmani A (2017) Fraud detection in E-banking by using the hybrid feature selection and evolutionary algorithms. *IJCSNS* 17:271
74. Prakash D, Lakshminarayana C (2016) Optimal siting of capacitors in radial distribution network using whale optimization algorithm. *Alex Eng J* 56:499–509
75. Prasad D, Mukherjee A, Shankar G, Mukherjee V (2017) Application of chaotic whale optimisation algorithm for transient stability constrained optimal power flow. *IET Sci Meas Technol* 11:1002–1013
76. Qiao W, Yang Z, Kang Z, Pan Z (2020) Short-term natural gas consumption prediction based on Volterra adaptive filter and improved whale optimization algorithm. *Eng Appl Artif Intell* 87:103323
77. Raj S, Bhattacharyya B (2017) Optimal placement of TCSC and SVC for reactive power planning using Whale optimization algorithm. *Swarm Evol Comput* 40:131–143
78. Reddy MPK, Babu MR (2018) Implementing self adaptiveness in whale optimization for cluster head section in Internet of Things. *Clust Comput* 22:1–12
79. Reddy PDP, Reddy VV, Manohar TG (2017) Whale optimization algorithm for optimal sizing of renewable resources for loss reduction in distribution systems. *Renew Wind Water Solar* 4:3
80. Rohani M, Shafabakhsh G, Haddad A, Asnaashari E (2016) The workflow planning of construction sites using whale optimization algorithm (WOA). *Turk Online J Des Art Commun* 6:2938–2950
81. Rosyadi A, Penangsang O, Soeprijanto A (2017) Optimal filter placement and sizing in radial distribution system using whale optimization algorithm. *International seminar on intelligent technology and its applications (ISITIA)*, 2017. IEEE, pp 87–92
82. Saidala RK, Devarakonda N (2018) Improved whale optimization algorithm case study: clinical data of anaemic pregnant woman. *Data engineering and intelligent computing*. Springer, Berlin
83. Saidala RK, Devarakonda NR (2017) Bubble-net hunting strategy of whales based optimized feature selection for e-mail classification. *Convergence in Technology (I2CT)*. In: *2nd International conference for*, 2017. IEEE, pp 626–631
84. Sayed GI, Darwish A, Hassanien AE, Pan J-S (2016) Breast cancer diagnosis approach based on meta-heuristic optimization algorithm inspired by the bubble-net hunting strategy of whales. In: *International conference on genetic and evolutionary computing*. Springer, Berlin, pp 306–313
85. Sharawi M, Zawbaa HM, Emary E (2017) Feature selection approach based on whale optimization algorithm. In: *9th International conference on advanced computational intelligence (ICACI)*. IEEE, pp 163–168
86. Shi Y, Eberhart RC (1999) Empirical study of particle swarm optimization. In: *Proceedings of the 1999 congress on evolutionary computation*, CEC 99. IEEE, pp 1945–1950
87. Simhadri KS, Mohanty B, Panda SK (2019) Comparative performance analysis of 2DOF state feedback controller for automatic generation control using whale optimization algorithm. *Optim Control Appl Methods* 40:24–42
88. Singh GP, Singh A (2014) Comparative study of krill herd, firefly and cuckoo search algorithms for unimodal and multimodal optimization. *Int J Intell Syst Appl* 6:35
89. Solís Gallego I, Meana FA, Argüelles DKM, Velarde SS, Fernández Oro JM, Menéndez AD (2015) Optimization of wind turbine airfoils using geometries based on humpback whale flippers. In: *International congress of energy and environment engineering and management*, Paris, pp 22–24
90. Song M, Chen D (2018) An improved knowledge-informed NSGA-II for multi-objective land allocation (MOLA). *Geo-Spat Inf Sci* 21:273–287
91. Sreenu K, Sreelatha M (2017) W-Scheduler: whale optimization for task scheduling in cloud computing. *Clust Comput* 1:1–12
92. Sun S, Yin Y, Wang X, Xu D, Wu W, Gu Q (2018) Fast object detection based on binary deep convolution neural networks. *CAAI Trans Intell Technol* 3:191–197
93. Sun Y, Yang T, Liu Z (2019) A whale optimization algorithm based on quadratic interpolation for high-dimensional global optimization problems. *Appl Soft Comput* 85:105744
94. Tharwat A, Moemen YS, Hassanien AE (2017) Classification of toxicity effects of biotransformed hepatic drugs using whale optimized support vector machines. *J Biomed Inform* 68:132–149

95. Touma HJ (2016) Study of the economic dispatch problem on IEEE 30-bus system using whale optimization algorithm
96. Trivedi IN, Bhoye M, Bhesdadiya R, Jangir P, Jangir N, Kumar A (2016a) An emission constraint environment dispatch problem solution with microgrid using whale optimization algorithm. National Power Systems Conference (NPSC). IEEE, pp 1–6
97. Trivedi IN, Jangir N, Jangir P, Pandya MH, Bhesdadiya R, Kumar A (2016b) Price penalty factors based approach for emission constrained economic dispatch problem solution using whale optimization algorithm. In: IEEE international conference on power electronics, intelligent control and energy systems (ICPEICES). IEEE, pp 1–5
98. Trivedi IN, Pradeep J, Narottam J, Arvind K, Dilip L (2016) Novel adaptive whale optimization algorithm for global optimization. Indian J Sci Technol 9:319
99. Tubishat M, Abushariah MA, Idris N, Aljarah I (2019) Improved whale optimization algorithm for feature selection in Arabic sentiment analysis. Appl Intell 49:1688–1707
100. Wang J, Du P, Niu T, Yang W (2017) A novel hybrid system based on a new proposed algorithm—multi-objective whale optimization algorithm for wind speed forecasting. Appl Energy 208:344–360
101. Xing B, Gao W-J (2016) Innovative computational intelligence: a rough guide to 134 clever algorithms. Springer, Berlin
102. Xu H, Bai Y, Xu T (2016) A whale optimization algorithm with inertia weight. Wseas Trans Comput 15:319–326
103. Yan Z, Sha J, Liu B, Tian W, Lu J (2018) An ameliorative whale optimization algorithm for multi-objective optimal allocation of water resources in Handan, China. Water 10:87
104. Yang X-S (2010) A new metaheuristic bat-inspired algorithm: Nature inspired cooperative strategies for optimization (NICSO 2010). Springer, Berlin
105. Yang X-S, Deb S (2014) Cuckoo search: recent advances and applications. Neur Comput Appl 24:169–174
106. Yang X-S, He X (2013) Firefly algorithm: recent advances and applications. Int J Swarm Intell 1:36–50
107. Yin B, Wang C, Abza F (2020) New brain tumor classification method based on an improved version of whale optimization algorithm. Biomed Signal Process Control 56:101728
108. Yin X, Cheng L, Wang X, Lu J, Qin H (2019) Optimization for hydro-photovoltaic-wind power generation system based on modified version of multi-objective whale optimization algorithm. Energy Procedia 158:6208–6216
109. Zamani H, Nadimi-Shahraki M-H (2016) Feature selection based on whale optimization algorithm for diseases diagnosis. Int J Comput Sci Inf Secur 14:1243
110. Zhang C, Fu X, Leo L, Peng S, Xie M (2018) Synthesis of broadside linear aperiodic arrays with sidelobe suppression and null steering using whale optimization algorithm. IEEE Antennas Wirel Propag Lett 17:347–350
111. Zhang H, Tang L, Yang C, Lan S (2019) Locating electric vehicle charging stations with service capacity using the improved whale optimization algorithm. Adv Eng Inform 41:100901
112. Zhang X, Liu Z, Miao Q, Wang L (2018) Bearing fault diagnosis using a whale optimization algorithm-optimized orthogonal matching pursuit with a combined time–frequency atom dictionary. Mech Syst Signal Process 107:29–42
113. Zhang Y, Liu Y, Li J, Zhu J, Yang C, Yang W, Wen C (2020) WOCDA: a whale optimization based community detection algorithm. Physica A 539:122937
114. Zhao C, Zhang S, Liu Q, Xie J, Hu J (2009) Independent tasks scheduling based on genetic algorithm in cloud computing. In: 5th International conference on wireless communications, networking and mobile computing, WiCom'09. IEEE, pp 1–4
115. Zhao H, Guo S, Zhao H (2017) Energy-related CO₂ emissions forecasting using an improved LSSVM model optimized by whale optimization algorithm. Energies 10:874
116. Zhou Y, Ling Y, Luo Q (2017) Levy flight trajectory-based whale optimization algorithm for global optimization. IEEE Access 1:1

Publisher's Note Springer Nature remains neutral with regard to jurisdictional claims in published maps and institutional affiliations.